

European Academies

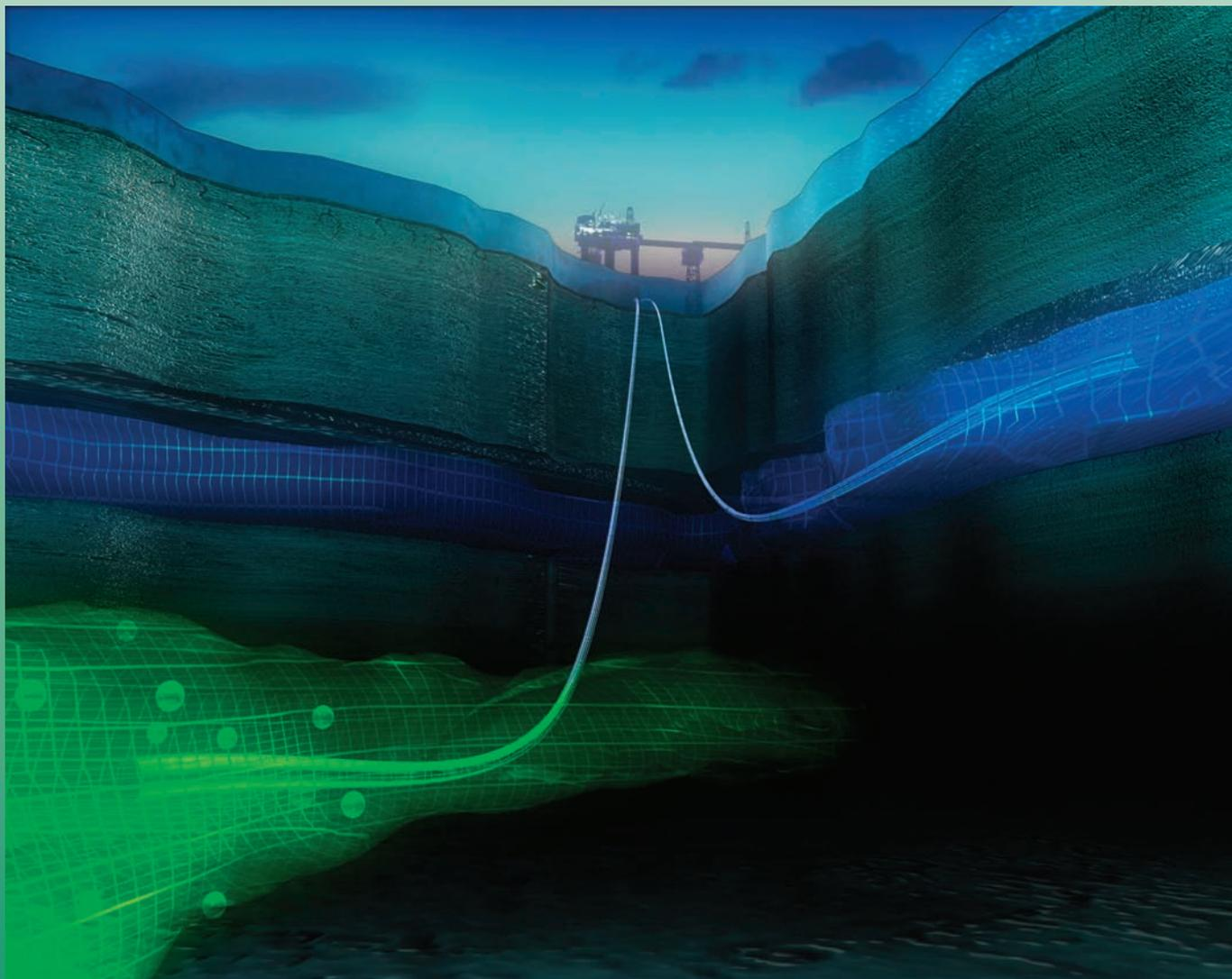

## Carbon capture and storage in Europe



EASAC policy report 20

May 2013

ISBN: 978-3-8047-3180-6

This report can be found at  
[www.easac.eu](http://www.easac.eu)

building science into EU policy

# EASAC

EASAC – the European Academies Science Advisory Council – is formed by the national science academies of the EU Member States to enable them to collaborate with each other in giving advice to European policy-makers. It thus provides a means for the collective voice of European science to be heard.

Its mission reflects the view of academies that science is central to many aspects of modern life and that an appreciation of the scientific dimension is a pre-requisite to wise policy-making. This view already underpins the work of many academies at national level. With the growing importance of the European Union as an arena for policy, academies recognise that the scope of their advisory functions needs to extend beyond the national to cover also the European level. Here it is often the case that a trans-European grouping can be more effective than a body from a single country. The academies of Europe have therefore formed EASAC so that they can speak with a common voice with the goal of building science into policy at EU level.

Through EASAC, the academies work together to provide independent, expert, evidence-based advice about the scientific aspects of public policy to those who make or influence policy within the European institutions. Drawing on the memberships and networks of the academies, EASAC accesses the best of European science in carrying out its work. Its views are vigorously independent of commercial or political bias, and it is open and transparent in its processes. EASAC aims to deliver advice that is comprehensible, relevant and timely.

EASAC covers all scientific and technical disciplines, and its experts are drawn from all the countries of the European Union. It is funded by the member academies and by contracts with interested bodies. The expert members of EASAC's working groups give their time free of charge. EASAC has no commercial or business sponsors.

EASAC's activities include substantive studies of the scientific aspects of policy issues, reviews and advice about specific policy documents, workshops aimed at identifying current scientific thinking about major policy issues or at briefing policy-makers, and short, timely statements on topical subjects.

The EASAC Council has 28 individual members – highly experienced scientists nominated one each by the national science academies of EU Member States, by the Academia Europaea and by ALLEA. The national science academies of Norway and Switzerland are also represented. The Council is supported by a professional Secretariat based at the Leopoldina, the German National Academy of Sciences, in Halle (Saale) and by a Brussels Office at the Royal Academies for Science and the Arts of Belgium. The Council agrees the initiation of projects, appoints members of working groups, reviews drafts and approves reports for publication.

To find out more about EASAC, visit the website – [www.easac.eu](http://www.easac.eu) – or contact the EASAC Secretariat at [secretariat@easac.eu](mailto:secretariat@easac.eu)

European Academies



Science Advisory Council

## Carbon capture and storage in Europe

ISBN 978-3-8047-3180-6

© German National Academy of Sciences Leopoldina 2013

Apart from any fair dealing for the purposes of research or private study, or criticism or review, no part of this publication may be reproduced, stored or transmitted in any form or by any means, without the prior permission in writing of the publisher, or in accordance with the terms of licenses issued by the appropriate reproduction rights organisation. Enquiries concerning reproduction outside the terms stated here should be sent to:

EASAC Secretariat  
Deutsche Akademie der Naturforscher Leopoldina  
German National Academy of Sciences  
Jägerberg 1  
D-06108 Halle (Saale)  
Germany  
tel: +49 (0)345 4723 9833  
fax: +49 (0)345 4723 9839  
email: [secretariat@easac.eu](mailto:secretariat@easac.eu)  
web: [www.easac.eu](http://www.easac.eu)

Cover image: Carbon storage at Sleipner. Credit: Alligator film /BUG. Copyright: Alligator film /BUG – Statoil.

Copy-edited and typeset in Frutiger by The Clyvedon Press Ltd, Cardiff, United Kingdom

Printed by DVZ-Daten-Service GmbH, Halle/Saale, Germany

# Contents

	<i>page</i>
<b>Foreword</b>	<b>v</b>
<b>Summary</b>	<b>1</b>
<b>1 Introduction</b>	<b>3</b>
<b>2 The EU policy context</b>	<b>5</b>
2.1 EU policy on CCS	5
2.2 The international policy context	6
2.3 Support for CCS development and demonstration in Europe	6
2.4 EU projections for CCS deployment	7
2.5 Concluding comments	8
<b>3 Capturing CO<sub>2</sub></b>	<b>11</b>
3.1 Introduction	11
3.2 Post-combustion capture	11
3.3 Oxy-combustion capture	15
3.4 Pre-combustion capture	17
3.5 Environmental impacts	20
3.6 Costs	22
3.7 Conclusions and recommendations on capture	24
<b>4 Transporting CO<sub>2</sub></b>	<b>25</b>
4.1 Transport options	25
4.2 Development status	25
4.3 Developing Europe's CO <sub>2</sub> transport infrastructure	27
4.4 CO <sub>2</sub> transport costs	29
4.5 Conclusions and recommendations on CO <sub>2</sub> transport for CCS in Europe	29
<b>5 Storing CO<sub>2</sub></b>	<b>31</b>
5.1 Processes of CO <sub>2</sub> storage	31
5.2 Current status of CO <sub>2</sub> storage	35
5.3 Understanding of CO <sub>2</sub> storage processes: current position and development needs	39
5.4 Reflections on the authorisation of CO <sub>2</sub> storage sites	43
5.5 Conclusions and recommendations on storage	45
<b>6 Alternative approaches</b>	<b>47</b>
6.1 Introduction	47
6.2 Ocean storage	47
6.3 Binding as carbonate minerals	47
6.4 CO <sub>2</sub> as a chemical product or feedstock	48
6.5 CO <sub>2</sub> for cultivation of algae	49
6.6 Biochar	50
6.7 Biomass with CCS	50
6.8 Direct capture of CO <sub>2</sub> from the air	51
6.9 Conclusions and recommendations on alternative approaches	52
<b>7 Public perception and engagement</b>	<b>53</b>
7.1 Introduction	53
7.2 Current attitudes and experience	53
7.3 Good practice in public engagement on CCS	55
7.4 Conclusions and recommendations on public engagement issues	56

<b>8</b>	<b>Prospects for CCS in Europe to 2050</b>	<b>57</b>
8.1	Economic considerations	57
8.2	Factors influencing future prospects	59
8.3	Prospects to 2050	62
<b>9</b>	<b>Conclusions</b>	<b>65</b>
9.1	CO <sub>2</sub> capture	65
9.2	CO <sub>2</sub> transport	65
9.3	CO <sub>2</sub> storage	65
9.4	Alternative approaches	66
9.5	Public engagement	66
9.6	Prospects for CCS in Europe up to 2050	66
<b>10</b>	<b>Recommendations</b>	<b>69</b>
10.1	Financial viability	69
10.2	Storage issues	69
10.3	The technology	70
10.4	CO <sub>2</sub> transport infrastructure	70
10.5	Public perception	70
	<b>References</b>	<b>71</b>
<b>Annex 1</b>	<b>Working Group membership, meetings and presentations</b>	<b>81</b>
<b>Annex 2</b>	<b>Glossary</b>	<b>83</b>
<b>Annex 3</b>	<b>Potential regional approach to CCS infrastructure development in Europe</b>	<b>85</b>

## Foreword

Carbon dioxide generated by power stations and industrial processes by burning fossil fuel and released into the atmosphere is causing significant concern. Carbon capture and storage (CCS) is the process whereby the carbon dioxide is captured before it is released to the atmosphere and is then transported to a secure underground storage facility. CCS is an important component of the European Union's policies and strategies for mitigating climate change, and for many European countries. But experience of commercial-scale operation is limited, and progress on developing CCS in Europe has stalled in recent years.

This report records the findings of an EASAC study to evaluate the challenges of CCS development in Europe, to make recommendations on how those challenges may be addressed, and to consider the contribution that CCS may reasonably be expected to make over the period to 2050.

The report concludes that CCS has the potential to make an important contribution to Europe's efforts to substantially decarbonise its electricity system and to achieve targets of greenhouse gas reduction. However, at present the economics of CCS are not viable and strong policy actions are needed urgently if the key next steps, in particular CCS demonstration plants and the first generation of commercial facilities, are to be realised.

Looking further ahead, several factors will constrain the rate of deployment of CCS, not least the substantial transport and storage infrastructure that will need to be created, the public perceptions that will play into

the permitting of these developments and the need to develop confidence in the geological processes that will determine the long-term security of the stored carbon dioxide. And although some reductions in the cost of CCS may be anticipated through research and development and learning-curve effects, CCS will continue to add to the costs of fossil-fired power stations and industrial processes. The value of avoiding the emission of a tonne of carbon dioxide needs to be sufficient, and sufficiently predictable, if the private sector is to make the major investments in CCS that are required.

We hope that the conclusions and recommendations set out in this report will provide a useful contribution to the current debate on CCS, its role in climate change mitigation in Europe and how we can enable that role to be fulfilled.

On behalf of EASAC I express sincere thanks to the Working Group members for their expertise, time and contributions, to the Working Group Chair, Professor Herbert Huppert of the University of Cambridge, for his leadership of the study, and to the Secretary, Dr John Holmes, for steering the project to a successful conclusion. We are also grateful for the inputs of other experts who made presentations to the Working Group, to the organisations and individuals who provided information to inform the study and to the peer reviewers who provided comments to enable us to finalise the report. All are listed in Annex 1 of the report.

Professor Sir Brian Heap,  
EASAC President



# Summary

Carbon capture and storage (CCS) is an important component of many national, European and worldwide strategies to tackle climate change. CCS can reduce greenhouse gas emissions by capturing the carbon dioxide (CO<sub>2</sub>) generated by large point sources before it is released to the atmosphere, and then transporting it to a secure underground storage facility.

The European Academies Science Advisory Council (EASAC) established a Working Group in October 2011 to examine the challenges that must be addressed to secure CCS as a viable component of strategies to mitigate climate change, and consequently to consider what contribution it may make in Europe up to 2050. This report presents the findings and recommendations of that EASAC study.

The three main technologies for **CO<sub>2</sub> capture** – post-combustion capture, pre-combustion capture and oxy-fuel combustion – are considered technologically feasible, but integrated operation on commercial-scale power stations remains to be demonstrated. They have broadly similar costs, adding around 50% to the levelised cost of electricity when applied to coal- or gas-fired power stations. Present and anticipated developments should bring this penalty down to 30–45% over the next 20 years, and further incremental improvements may be expected beyond that timescale. More substantial improvements based on radically new technologies and configurations are currently speculative.

**Transport of CO<sub>2</sub>** may be by pipelines or ships, the latter potentially being favoured for small and/or remote offshore locations or where flexibility is required, particularly in start-up phases. For ship transport, scale-up to commercial capacities in the context of CCS needs to be demonstrated. For pipelines, further research, development and demonstration work over a period of 5–10 years should provide the necessary confidence in their economic and safe design and operation in light of anticipated impurities in the CO<sub>2</sub> and variable load operation of the CO<sub>2</sub> sources. The development and operation of an integrated, cross-border CO<sub>2</sub> transport infrastructure in Europe, linking large networks of capture and storage sites, represent a major institutional and logistical challenge. However, there are no insurmountable technical problems facing pipeline transport.

The processes of **CO<sub>2</sub> storage** are broadly understood, but significant uncertainties remain which will need to be addressed to provide sufficient confidence to regulators and the public that CO<sub>2</sub> storage will be safe over the long term. The precise levels of confidence that will eventually be required in respect of the various issues affecting the long-term safety of CO<sub>2</sub> storage, and the consequent degree of resolution of these uncertainties that will

be expected, will emerge from an iterative process of confidence building between developers and regulators, in which publics should play an active part. Acceptable levels of confidence and resolution of uncertainties will be influenced by the urgency of action to mitigate climate change on the one hand, and by liability issues, public concerns and the long periods over which CO<sub>2</sub> must be safely stored on the other.

The rate at which uncertainties can be resolved, and knowledge gained, will be constrained by the need to observe geological processes, some over periods of years to build sufficient understanding, but others (for example CO<sub>2</sub> migration and retention processes, and borehole seal integrity) potentially over decades. Similarly, characterisation of a candidate storage site to achieve sufficient confidence to commit to CO<sub>2</sub> injection may take several years, and generally more for saline aquifers, where the major part of estimated storage capacity rests, than for mature and depleted oil and gas fields given their previous characterisation. These factors will be an important influence on the rate at which CCS can be deployed in Europe. An early priority is to develop a better characterisation of Europe's potential CO<sub>2</sub> storage sites.

**Public perceptions** will have an important bearing on the progress of CCS in Europe. There is a case for more concerted initiatives at European Union (EU) and national levels to debate the value of CCS in the context of climate-change mitigation strategies, and consequently to build awareness and acceptance of the potential of CCS as an option for climate change mitigation. The social setting for CO<sub>2</sub> storage facilities may need to be given greater weight, alongside the suitability of the geological setting and location in relation to capture sites, in deciding where to locate CO<sub>2</sub> storage facilities.

Consideration has been given to **alternatives** to 'mainstream' CCS such as biochar, use of biomass with CCS, waste carbonation, algae cultivation and CO<sub>2</sub> use in chemical processes, which have already reached the pilot and demonstration stages. It is concluded that for the near term, there seem to be no feasible alternative approaches capable of making a major contribution to climate change mitigation, although there are several interesting concepts being developed that could provide some modest additional means for reducing greenhouse gas emissions in the future.

With regard to the **current position of CCS in Europe**, a picture emerges of delays in, and downsizing of, the first steps (in particular the proposed set of demonstration plants), of continuing challenges to the economic viability of CCS and of difficulties of public acceptance which may constrain the possible locations and rates of development of transport and storage infrastructures. Confidence in

the safety and permanence of CO<sub>2</sub> storage is likely to build relatively slowly.

Looking forward to the **prospects for CCS in Europe**, an outcome at the lower end of the ranges considered by the European Commission in establishing the CCS Directive, and more recently in the Roadmap 2050 exercise, may be a more realistic central case. The core of this contribution would lie in CCS applications with favourable juxtapositions of sources, sinks and public acceptance. From an electricity systems point of view, it would focus on situations where CCS enables fossil-fired power stations to play a key role in balancing supply and demand in an electricity system having close-to-zero greenhouse gas emissions and relying primarily on renewable energy sources, and possibly nuclear power. Positioning CCS in this way may help to overcome opposition founded on a belief that pursuit of CCS will be at the expense of developing renewable sources.

At present, the financial and policy conditions are not in place in Europe to attract private investment in CCS. Initial enthusiasm for CCS appears to be waning under the harsh spotlight of funding demonstration plants and the first-generation commercial facilities that should follow. Unless decisive policy actions are taken to address this issue, and to provide investors with sufficient confidence in returns over the lifetime of projects, this situation looks set to continue. If CCS is to make a significant contribution in Europe to climate change mitigation, technologies, capacity and infrastructure need to be developed steadily and with greater urgency than currently prevails. CCS is not a tap that can simply be turned on, if and when suitable financial conditions emerge or future policy makers decide that CCS is a crucial component of Europe's energy strategy.

**Recommendations** from the study concern the **financial viability** of CCS, **storage issues**, **CCS technology development**, **CO<sub>2</sub> transport** and **public engagement**.

With regard to the **financial viability** of CCS, consideration should be given to additional funding mechanisms to augment EU allowances from the EU Emissions Trading Scheme (ETS), such as feed-in tariffs or 'contracts for difference', to tip the economics in favour of CCS deployment, and to the appropriate division of risks between governments and commercial developers. The ETS should be extended to include alternative technologies such as the use of biomass with CCS, carbonation and CO<sub>2</sub> use under the condition that the mitigation effect from the life cycle of these options (especially in the case of CO<sub>2</sub> use) is significant, and can be measured and proven.

Achieving adequate funding of the capital and operating costs of EU demonstration plants is an immediate priority: current rules for funding the demonstration projects may

need to be revisited. Although funding constraints may limit the initial number of demonstration plants to three or four, a second tranche of demonstration plants should be planned for and financed to demonstrate an adequate range of technologies and application options.

Care must be taken in pushing forward CCS that carbon-intensive industries are not driven to other regions where there are fewer restrictions ('carbon leakage') through well-designed packages of regulatory and financial measures. The EU should continue to influence developments globally to secure the introduction of similar levels of environmental protection elsewhere.

On **storage issues** it is recommended that a strong focus be placed on activities to accelerate confidence building on the permanence and safety of CO<sub>2</sub> storage, including clarifying and elaborating regulatory frameworks, and fast-tracking several storage facilities through the complete regulatory process to minimise associated uncertainties as the volumes of stored CO<sub>2</sub> accumulate. The demonstration plants are essential to provide data at large scale and should be developed as soon as possible. They should be complemented by more pilot-scale injection test sites, perhaps five or six in total, which may be able to be implemented and deliver useful results on shorter timescales.

An early, and major, strategic investment should be made to locate and characterise Europe's CO<sub>2</sub> storage capacity, so that a significantly more confident picture is developed than is available now, and to enable an integrated approach to the development of Europe's CCS infrastructure.

The report has identified the R&D activities necessary for **CCS technology development** which are appropriately funded at an EU level through mechanisms that ensure results are made publically available, subject to not compromising commercial incentives. Demonstration plants should be set up to have sufficient flexibility to test a range of options.

A strategic and pan-European approach should be taken to developing Europe's **CO<sub>2</sub> transport** infrastructure, both pipelines and ships, which should be on a par with critical developments in Europe's electricity grid and natural gas pipeline networks in respect of policy attention, EU support and enabling mechanisms. Ship transport of CO<sub>2</sub> should be fully incorporated into the provisions of the CCS Directive.

An enhanced emphasis should be placed on **public engagement** and debates about the role of CCS in mitigating climate change at EU and national levels in relation to other options, to increase awareness and to put decisions to proceed with CCS on a firmer footing. These debates should enable a better understanding to be developed of publics' attitudes to CCS and why they are formed.

# 1 Introduction

Carbon capture and storage (CCS) reduces greenhouse gas emissions by trapping the carbon dioxide (CO<sub>2</sub>) generated by large point sources before it is released to the atmosphere, and then transporting it to a secure underground storage facility (see illustration of CCS processes in Figure 1.1). It forms an important component of many national, European and worldwide strategies to tackle climate change. Mitigating climate change is a key policy priority for the European Union (EU), which emitted 3.8 gigatonnes (Gt)\* of CO<sub>2</sub> in 2009, around 13% of

the world total (European Environment Agency, 2011b; International Energy Agency, 2010).

Studies by the Intergovernmental Panel on Climate Change (2005), the Major Economies Forum (2009) and the International Energy Agency (IEA, 2010) have pointed to the need for substantial deployment of CCS to fossil-fired power generation and industrial processes to minimise the predicted costs of meeting abatement goals for greenhouse gases. The CCS Roadmap developed in

Figure 1.1 Illustration of CCS. Source: US Department of Energy, 2012a.

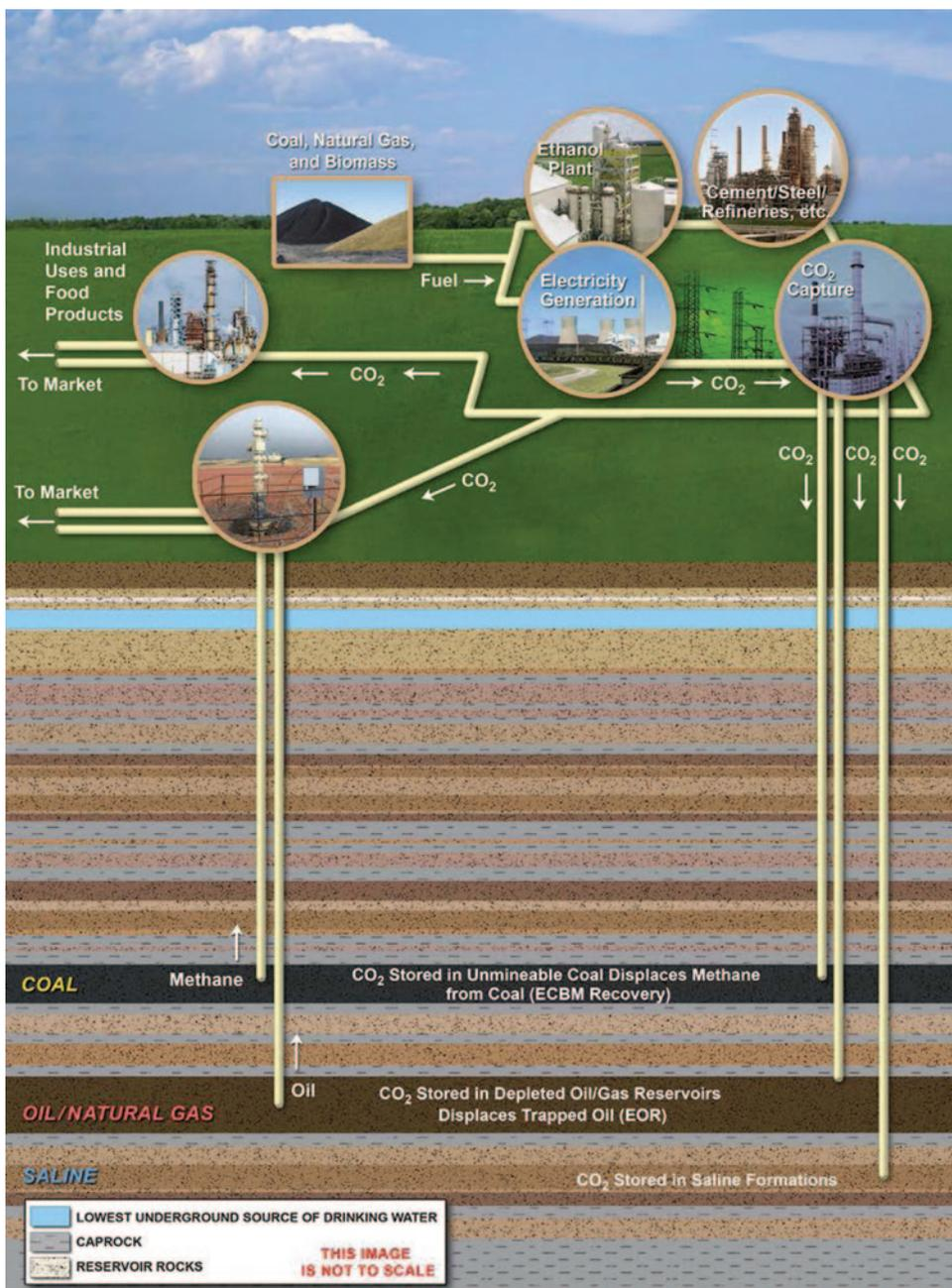

\* 1 Gigatonne = 10<sup>9</sup> tonnes.

2009 by the IEA (2009) anticipated that 100 CCS projects should be deployed by 2020, and 3400 by 2050 (at a total cost of €1.8–2.3 trillion) to achieve a 50% reduction in greenhouse gas emissions in the most cost-effective way by 2050. In this ‘blue map’ scenario, CCS contributes 20% of the required emission reductions. Although the developed world is expected in these projections to take a lead in establishing and deploying CCS technologies, two-thirds of the required CCS installations will be in China, India and developing countries in 2050.

CCS emerged rapidly as a preferred policy option in the years after 2000, perhaps at least in part because of its roots in the established fossil fuel regime, and the support of a powerful coalition of associated actors (see Stephens and Liu, 2012). However, although some initial applications of CCS have been made for enhanced oil and gas recovery and for natural gas processing, experience so far of application of CCS for power generation is very limited. Challenges remain to minimise cost and efficiency penalties, and to demonstrate safe, long-term storage of CO<sub>2</sub>. In recent years, concerns have grown that CCS may not deliver on the timescales anticipated by policy makers, and it is no longer generally considered realistic that 100 CCS projects will be operational by 2020.

The European Academies Science Advisory Council (EASAC) established a Working Group in October 2011 to examine the challenges that must be addressed to secure CCS as a viable component of strategies to mitigate climate change, and consequently to consider what contribution it may make in Europe up to 2050. This report presents the findings and recommendations of that EASAC study, and seeks to inform policy makers at an EU and Member State level concerned with climate change mitigation in general, and CCS in particular.

The specific objectives of the study have been the following.

1. Consider how the cost and efficiency penalties of CO<sub>2</sub> capture can be substantially reduced through advanced technologies and new CCS pathways; and consequently what further research, development and demonstration activities are needed.
2. Evaluate the levels of confidence in the long-term storage of CO<sub>2</sub> that can realistically be achieved and how they can be demonstrated to the satisfaction of regulators and the public. Identify monitoring requirements and what further developments are

needed in the science to support decision making processes and to inform public opinion.

3. Consider the relative roles of proposed alternative approaches to carbon sequestration such as ‘biochar’ and mineral carbonation.
4. Draw together findings in the three previous areas, and take a view on the realism of current European planning assumptions on the contribution of CCS up to 2050.

Although the main focus of the report is on the application of carbon capture to power generation, some consideration is given at appropriate points in the text to CCS in relation to industrial processes such as cement and steel manufacture, and refineries.

The study was conducted from October 2011 to March 2013 by a Working Group (whose membership is listed in Annex 1) comprising experts nominated by EASAC member academies, and chaired by Professor Herbert Huppert, University of Cambridge.

The Working Group met four times, in the UK, Switzerland, Belgium and Germany, taking evidence from invited experts, discussing and refining findings and recommendations, and agreeing the consequent text of the report (details are given in Annex 1). Both open and targeted calls for inputs and evidence were made. The Working Group’s final draft report was subjected to EASAC’s rigorous peer-review process before finalisation and publication in May 2013. The findings and recommendations presented in this report are based on the Working Group’s expert analysis and evaluation of available sources of information, rather than on new research and modelling.

After a review of the current policy context for CCS in Europe in Chapter 2, the following three chapters examine in turn the three main components of CCS: CO<sub>2</sub> capture, transport and storage. Chapter 6 then considers alternatives to the mainstream CCS options, responding to the third objective of the study listed above. A key issue for CCS is public perception and engagement, which is addressed in Chapter 7. Chapter 8 then draws together the threads developed in earlier chapters to evaluate the factors that will influence the prospects for CCS in Europe up to 2050. Conclusions and recommendations follow, with a bibliography of the references informing this report, and annexes, providing supporting details.

## 2 The EU policy context

This chapter examines the policy context for CCS in Europe, initially summarising EU policy developments so far, and then looking briefly at key international conventions and initiatives relevant to CCS developments in Europe. Sections follow on EU initiatives on research, development and demonstration of CCS, and on EU projections for CCS deployment up to 2050. Some concluding comments round off the chapter.

### 2.1 EU policy on CCS

The EU's **energy policy** sets out ambitious energy and climate change objectives, including a compulsory 20% reduction in greenhouse gas emissions by 2020 compared with 1990 levels (30% if international conditions are right) (European Commission 2007c, 2010b). A 16% reduction had been achieved by 2011 (European Commission, 2013b). In the longer term, a commitment has been made to 'decarbonise' energy supply substantially, with a target to reduce by 2050 EU greenhouse gas emissions by 80–95% compared with 1990 levels. Re-affirmed by the European Council in February 2011, this objective requires the EU's electricity system to achieve essentially zero emissions of greenhouse gases by 2050 (European Commission, 2011b). The central goals of EU energy policy – security of supply, competitiveness and sustainability – have been laid down in the Lisbon Treaty (European Union, 2007).

The energy policy recognises that coal and gas currently account for 50% of the EU's electricity supply, and anticipates that they will continue to be an important part of the EU's energy mix, and globally, for many years. It therefore considers that the EU should show global leadership and, '... provide a clear vision for the introduction of CO<sub>2</sub> capture and storage in the EU, establish a favourable regulatory framework for its development, invest more, and more effectively, in research, as well as taking international action' (European Commission, 2007c). Reiterating statements made in the communication on sustainable power generation (European Commission, 2007b), the Commission made commitments to design a mechanism to stimulate the construction and operation by 2015 of up to 12 large-scale demonstrations of sustainable fossil fuel technologies in commercial power generation (i.e. CCS), and to provide a clear perspective on when coal- and gas-fired plants will need to install CCS.

The Energy Policy was followed by binding legislation to secure delivery of its targets – the '**climate and energy package**' – which was agreed by the European Parliament and Council in December 2008 and became law in June 2010. One of four pieces of complementary legislation contained in the package was Directive

2009/31/EC on the geological storage of CO<sub>2</sub> – the '**CCS Directive**' (European Commission, 2009a) – prepared by the Commission's Directorate General for Environment. This constitutes a wide-ranging legal framework for the management of environmental and health risks related to CCS, including requirements on composition of CO<sub>2</sub> streams, permitting, monitoring, reporting, inspections, corrective measures, closure and post-closure obligations, transfer of responsibility to the state and financial security.

The CCS Directive was required to be transposed by the EU Member States by 25 June 2011. To support, and ensure uniformity between, Member States in its implementation, the Commission published four **Guidance Documents** on various elements of the CCS Directive on 31 March 2011 (European Commission 2011a, c–e). By 11 August 2011 Member States were required to submit questionnaires on the implementation of the EU CCS Directive to the Commission, based on which the Commission would prepare a report for submission to the European Parliament and Council by May 2012.

In the event, just two EU Member States, Spain and Romania, had reported full transposition of the Directive by the June 2011 deadline (Joint Research Centre, 2011), and still only eight had done so by July 2012 (Hinc, 2012). Consequently, the legislative framework for CCS was not yet in place in most EU Member States at that time.

A review of experience of implementing the Directive is required to be undertaken by June 2015, which may lead to its revision (European Commission, 2009a, Article 38). The review provides for the further development and updating of the criteria for storage site characterisation, assessment and monitoring set out in Annexes 1 and 2 of the Directive. At this time, consideration will be given to whether it is necessary and practical to establish mandatory requirements for emission performance standards for new large combustion installations generating electricity. The effect of such requirements had been considered in the impact assessment which supported the development of the Directive (European Commission, 2008c), but it was concluded that enabling CCS to become eligible for emissions credits under the ETS (subsequently enacted in 2009: European Commission, 2009d) should provide sufficient economic stimulus for the development and deployment of the technology in Europe.

Land use planning regulations and processes are recognised in the EU's energy strategy (European Commission, 2010b) as potentially posing a major impediment to the rapid development of CO<sub>2</sub> infrastructure, in particular pipeline networks. Across Europe, the period experienced by major

infrastructure projects for planning and gaining consent regularly exceeds 10 years (Element Energy, 2010). The development of a cross-border network for CO<sub>2</sub> transport has therefore been included in the Commission's 2011 proposal for the regulation and support of critical trans-European energy infrastructure (European Commission, 2011h), which seeks to streamline permit granting procedures and to provide the necessary market-based and direct EU financial support to enable implementation of projects of common interest.

## 2.2 The international policy context

Three international conventions are of particular relevance to CO<sub>2</sub> transport and storage in Europe (Element Energy, 2010):

- The **Basel Convention**, which controls the trans-boundary movement of waste. However, the EU CCS Directive has removed its requirements in relation to shipment of CO<sub>2</sub> within, and between, EU Member States by dis-applying the Trans-frontier Shipment of Waste Regulation.
- The **OSPAR Convention**, an amendment to which now permits the storage of overwhelmingly pure CO<sub>2</sub> provided that disposal is into a sub-soil geological formation, is intended to be retained permanently, and will not lead to significant adverse effects.
- The **London Convention and Protocol**, which may pose a legal barrier to trans-boundary movement of CO<sub>2</sub> where it is to be stored in geological media under the seabed. Amendments adopted by contracting parties in 2006 now allow CO<sub>2</sub> from CCS schemes to be stored in sub-seabed geological formations, provided no wastes or other matter are added. However, Article 6 of the Convention still prohibits the export of CO<sub>2</sub> streams from the jurisdiction of one country to another. Norway has proposed an amendment to address this problem but it has not yet come into force as sufficient parties to the Protocol have not yet ratified the amendment. Concerns have been expressed that implementation may take a long time (Evar et al., 2012).

In 2011 in Durban, the Conference of the Parties to the Kyoto Protocol adopted a decision to include CCS within the list of activities eligible under the Clean Development Mechanism (CDM). CCS activities meeting requirements to be established by the Clean Development Mechanism will be able to generate Certified Emission Reduction units – the carbon credits produced by Clean Development Mechanism projects – to account against Annex I mitigation targets under the Kyoto Protocol. Further discussion of CCS-related issues at COP-18 in Doha concerned trans-boundary projects and the creation

of a global reserve of certified emission reduction units for CCS projects, but deferred further consideration to the 45th session of the Subsidiary Body for Scientific and Technological Advice (anticipated to be held in 2016) (Dixon, 2012).

## 2.3 Support for CCS development and demonstration in Europe

A European '**Strategic Energy Technology Plan** (SET-Plan)' was developed in 2007 to accelerate the development of low carbon technologies (European Commission, 2007a), and subsequently endorsed by the EU in light of the conclusion by the 2nd Strategic European Energy Review (European Commission, 2008a) that, '... the EU will continue to rely on conventional energy technologies unless there is a radical change in our attitude and investment priorities for the energy system.' It describes, '... a vision of a Europe with world leadership in a diverse portfolio of clean, efficient and low-carbon energy technologies as a motor for prosperity and a key contributor to growth and jobs.' Enabling commercial use of CCS through demonstration at industrial scale is identified as one of the key technology challenges for the next 10 years to meet the 2020 targets.

'**Technology roadmaps**' were subsequently developed by the Commission in consultation with stakeholders for each of the key technologies identified in the SET-Plan (European Commission, 2009b, c). One of these was for CCS. The roadmaps provide, '... a master plan of the efforts needed over the next 10 years ...', and set the target for CCS that it will be, '... cost-competitive within a carbon-pricing environment by 2020-2025.' The Commission also established six **European Industrial Initiatives** (EIs), of which one is concerned with CCS, which will develop detailed implementation plans.

The technology objectives of the CCS EI are to 'prove the technical and economic feasibility of CCS using existing technology' and to 'develop more efficient and cost competitive CCS technologies'. The stated aim is to reduce CCS costs from €60–90 per tonne of CO<sub>2</sub> currently, to €30–50 per tonne by 2020 which, in 2009, was anticipated to make it cost-competitive within a carbon pricing environment provided by the EU ETS (European Commission, 2009b–d). The associated investment costs, largely for CCS demonstration plants, were estimated by the Commission (2009c) to be €10.5 billion to €16.5 billion over the period to 2020.

The CCS EI has established an implementation plan for 2010–2012 (Zero Emissions Platform (ZEP), 2010); further plans will follow, starting with a plan for 2013–2015. Specific tasks of the CCS EI include identification of priority actions; synchronisation of agendas through coordination of timelines and actions; identification and management of synergies between ongoing activities and

possible interdependencies of risks between activities; and monitoring and reporting of progress to stakeholders in reaching EII objectives.

In 2010, the European Energy Programme for Recovery allocated €1 billion in funding to six **CCS demonstration plants**, which taken together were intended to demonstrate integrated operation of CCS for all three main CO<sub>2</sub> capture technologies (post-combustion, oxy-combustion and pre-combustion), and the main storage options (onshore as well as offshore saline aquifer and depleted hydrocarbon fields) (European Commission, 2010a). By May 2012, one of the six demonstration projects allocated funding by the European Energy Programme for Recovery had been abandoned, operational dates for two had been delayed until after 2018, full funding for the remaining three projects had not yet been secured, and they had all been delayed beyond the intended 2015 start-up target (Lowe, 2012). Reporting on the implementation of the European Energy Programme for Recovery in August 2012, the Commission indicated '... the CCS sub-programme as a whole is facing some major regulatory and economic uncertainties that risk undermining its successful implementation.', and concluded '... that the future of CCS is at a crossroad' (European Commission, 2012b).

A second source of funding for these, and additional, CCS demonstration projects is the 'NER300' funding programme managed by the Directorate General for Climate Action (<http://ec.europa.eu/clima/funding/ner300/>). This will allocate 300 million EU allowances set aside from the New Entrants Reserve of the EU ETS to support demonstration of CCS and innovative renewables. At the deadline of May 2011 for the first call for proposals (European Commission, 2010c), planned to allocate 200 million of the 300 million EU allowances (not all to CCS), 13 CCS proposals had been submitted: seven from the UK, and one each from France, Germany, Italy, the Netherlands, Poland and Romania (Joint Research Centre, 2011).

The call specified that at least eight CCS projects were to be funded in the first round (subject to the availability of sufficient funding from sale of EU allowances), selected to ensure a diversity of technologies, with at least three having hydrocarbon reservoir storage and three, saline aquifer storage. The funding is being allocated in two rounds so that adjustments can be made in the second round in light of the technological, geographical and geological representation of projects after the first round decisions. The call indicated that funding from NER 300 will be limited to 50% of the relevant costs, and that no one project may receive more than 15% of the total funding available.

In the event, the value of EU allowances from the ETS was substantially below that anticipated (the first 200

million allowances realising around €8 per allowance from December 2011 to September 2012). And, problematically for CCS, no CCS projects were funded in the first round: most CCS projects had not been confirmed by their host Member States, and therefore were ineligible for funding (European Commission, 2012a). The second round of funding, which will allocate the remaining 100 million EU allowances, along with €275 million envisaged for CCS projects in the first round, was launched in April 2013.

In 2012, the low value of EU allowances in conjunction with the generally difficult economic conditions, meant that a total of 12 demonstration projects was no longer considered feasible by many in the CCS community: a more realistic aim of three or four was being discussed.

## 2.4 EU projections for CCS deployment

The CCS Directive (European Commission, 2009a) points to the potential contribution of CCS as a result of the Directive: 'Preliminary estimates, carried out with a view to assessing the impact of the Directive and referred to in the impact assessment of the Commission, indicate that seven million tonnes of CO<sub>2</sub> could be stored [annually] by 2020, and up to 160 million tonnes [annually] by 2030, assuming a 20% reduction in greenhouse gas emissions by 2020 and provided that CCS obtains private, national and Community support and proves to be an environmentally safe technology. The CO<sub>2</sub> emissions avoided in 2030 could account for some 15% of the reductions required in the Union.'

These figures were generated in the preparation of the Impact Assessment that accompanied the CCS Directive (European Commission, 2008c) and were produced by the PRIMES model which 'assesses the direct and indirect impact of policy options by simulating the impacts of the market'. Several policy 'options for internalising the positive externalities of CCS' were modelled: the options and modelling results are reproduced in Table 2.1. The Impact Assessment concludes that option 1, which just relies on the ETS to incentivise CCS, is preferred on economic grounds: 'On this basis, there is little evidence justifying going beyond the carbon market', and that, '...without CCS the costs of meeting a reduction in the region of 30% GHG in 2030 in the EU could be up to 40% higher than with CCS'. The model projects CO<sub>2</sub> storage of 800–850 million tonnes (MT) annually by 2050 in the market-based scenario (European Commission, 2008b).

The Energy Roadmap 2050, published in 2011 (European Commission, 2011f), explores the challenges posed by delivering the EU's decarbonisation objective through a set of illustrative scenarios (reproduced in Table 2.2) to examine the impacts, challenges and opportunities of possible ways of modernising the energy system. For each scenario, cost minimisation modelling is used to calculate

**Table 2.1 PRIMES model projections for impact assessment for CCS Directive (European Commission, 2008c)**

Million tonnes per annum of CO <sub>2</sub> captured by CCS							
	Option 0	Option 1: ETS	Option 2: ETS + mandatory				Option 3 ETS + subsidy
			2a	2b	2c	2d	
2020	0	7	7	7	37	75	0
2025	0	20	20.6	26.5	118	177	22
2030	0	161	267	391	326	517	211

All the options to be considered are based on meeting the EU's agreed climate objective of 20% GHG reduction by 2020 plus a 20% share of renewables by 2020. The options considered are the following:

- Option 0: no enabling policy for CCS at EU level, including no inclusion of CCS in the EU ETS (that is, achievement of climate objectives without CCS).
- Option 1: enable CCS under the EU ETS.
- Option 2: in addition to enabling under the ETS, impose an obligation to apply CCS from 2020 onwards and assess the impact on the potential positive externalities not captured by the carbon market. Four principal sub-options were considered:
  - (a) making CCS mandatory for new coal-fired power from 2020 onwards;
  - (b) making CCS mandatory for new coal- and gas-fired power from 2020 onwards;
  - (c) making CCS mandatory for new coal-fired power from 2020 onwards, together with retrofit of existing plants (built between 2015 and 2020) from 2020;
  - (d) making CCS mandatory for new coal- and gas-fired power from 2020 onwards, together with retrofit of existing plants (built between 2015 and 2020) from 2020.
- Option 3: in addition to enabling under the ETS, apply a subsidy so as to internalise the positive externalities not captured by the market.

the projected contributions of CCS and other technologies over the period to 2050. The projected shares of power generation for fossil-fired stations with CCS range from 7 to 32% (European Commission, 2013a).

The report on the Roadmap concludes, 'Carbon Capture and Storage (CCS), if commercialised, will have to contribute significantly in most scenarios with a particularly strong role of up to 32% in power generation in the case of constrained nuclear production and shares between 19 to 24% in other scenarios with the exception of the High RES scenario' (as summarised in Figure 2.1). Corresponding, cumulative CO<sub>2</sub> storage requirements up to 2050 range from 3 billion to 13 billion tonnes (9 billion tonnes in the reference scenario) (European Commission, 2011g).

The report also concludes, 'For all fossil fuels, Carbon Capture and Storage will have to be applied from around 2030 onwards in the power sector in order to reach the decarbonisation targets. CCS is also an important option for decarbonisation of several heavy industries and combined with biomass could deliver "carbon negative" values. The future of CCS crucially depends on public acceptance and adequate carbon prices; it needs to be sufficiently demonstrated on a large scale and investment in the technology ensured in this decade, and then deployed from 2020, in order to be feasible for widespread use by 2030.'

Some caution is needed in the reliance that is placed on such modelling projections: historically, such projections have a track record of inaccuracy (Hansson, 2012). They often prove to be strongly reliant on input assumptions. The transparency of the EU modelling studies (together with those of the International Energy Agency,

Intergovernmental Panel on Climate Change and Major Economies Forum referred to in Chapter 1) could usefully be enhanced, and more sensitivity studies would be helpful to better understand the impact of key parameter values.

There is also a tendency to 'over-interpret' model outputs: for example, results of cost minimisation modelling are translated to 'must do' statements. The conclusion from the Roadmap 2050 report, quoted above, provides an example of this tendency. The IEA (2010) and IPCC (2005) studies have similarly been misrepresented as establishing a requirement for CCS (Hansson, 2012).

## 2.5 Concluding comments

Over the past five years, initial aspirations for up to 12 CCS demonstration projects, operational by 2015, have been replaced by discussion of three to four projects as a more realistic target, with possible delays resulting in anticipated start-up dates tending towards 2020. Analysis at the start of this 5-year period (for example the impact assessment in support of the CCS Directive and the SET-Plan) looked to a significant contribution from CCS beginning in 2020. Analysis in support of Energy Roadmap 2050, published towards the end of the period, suggests a significant contribution of CCS only beginning in 2030.

These observations are symptomatic of significant slippage in the development of CCS in Europe, in part because of the difficult economic conditions that have prevailed, but perhaps also to over-optimistic expectations of CCS proponents, researchers and policy makers in the first instance. Such slippage is of

**Table 2.2 Scenarios considered in 'Energy Roadmap 2050'**

Current trend scenarios	
•	<b>Reference scenario:</b> this includes current trends and long-term projections of economic development (gross domestic product growth 1.7% per annum). The scenario includes policies adopted by March 2010, including the 2020 targets for the share of renewable energy sources and greenhouse gas reductions as well as the ETS Directive. For the analysis, several sensitivities with lower and higher gross domestic product growth rates and lower and higher energy import prices were analysed.
•	<b>Current policy initiatives:</b> this scenario updates measures adopted, for example after the Fukushima events following the natural disaster in Japan, and being proposed, as in the Energy 2020 strategy; the scenario also includes proposed actions concerning the 'Energy Efficiency Plan' and the new 'Energy Taxation Directive'.
Decarbonisation scenarios	
•	<b>High energy efficiency:</b> political commitment to very high energy savings; it includes, for example, more stringent minimum requirements for appliances and new buildings; high renovation rates of existing buildings; establishment of energy savings obligations on energy utilities. This leads to a decrease in energy demand of 41% by 2050 compared with the peaks in 2005–2006.
•	<b>Diversified supply technologies:</b> no technology is preferred; all energy sources can compete on a market basis with no specific support measures. Decarbonisation is driven by carbon pricing assuming public acceptance of both nuclear and CCS.
•	<b>High renewable energy sources (RES):</b> strong support measures for RES leading to a very high share of RES in gross final energy consumption (75% in 2050) and a share of RES in electricity <i>consumption</i> reaching 97%.
•	<b>Delayed CCS:</b> similar to the diversified supply technologies scenario but assuming that CCS is delayed, leading to higher shares for nuclear energy with decarbonisation driven by carbon prices rather than technology push.
•	<b>Low nuclear:</b> similar to the diversified supply technologies scenario but assuming that no new nuclear reactors (besides those currently under construction) are built, resulting in a higher penetration of CCS (around 32% in power generation).

Figure 2.1 Projected share of CCS in EU power generation (%) in energy system modelling for the 2050 Roadmap. Source: Lowe, 2012; European Commission, 2013a. Scenarios as considered in the 2050 Roadmap: see Table 2.2 and European Commission (2011f).

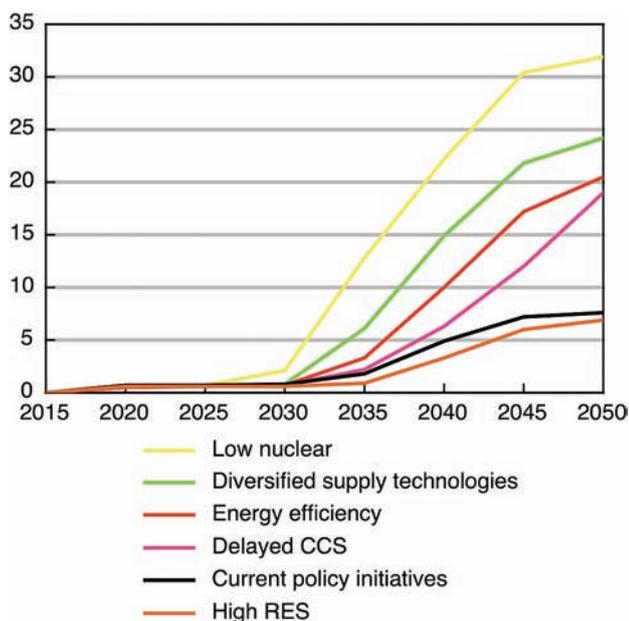

particular concern as CCS is envisaged as a 'bridging technology' to a low-carbon EU energy system (European Commission, 2009a), and because fossil-fired capacity may continue to be built, nominally 'capture ready' but further locking in fossil fuel use without the reassurance of a proven CCS retrofit option. It is also of concern if it results in the need for a rapid ramp-up in CCS capacity at some point in the future, which may cause problems in respect of the supply of CCS plants and the availability of underground storage capacity, and be more expensive than a more gradual build-up of capacity.

At the end of March 2013, shortly before the publication of this report, the Commission launched a consultative communication on the future of CCS in Europe (European Commission, 2013a) to stimulate a public debate on how to kick-start the currently stalled European initiative on CCS. It indicates that 'time is running out' and identifies the lack of a long-term business case and the cost of the CCS technology as the main problems. It also cites additional factors such as strong public opposition to onshore storage, decisions of some Member States to ban CO<sub>2</sub> storage, and the lack of adequate CO<sub>2</sub> transport infrastructure to connect CO<sub>2</sub> sources to sinks efficiently.



## 3 Capturing CO<sub>2</sub>

### 3.1 Introduction

Current natural gas and coal-fired power stations with a generating capacity of 500 megawatts of electricity (MW<sub>e</sub>) produce around 180 and 400 t of CO<sub>2</sub> per hour, respectively, from the combustion of the fuel. The challenge for capturing the CO<sub>2</sub> is not just the amounts involved, but the dilution of the CO<sub>2</sub> with other gases from which it must be separated: the concentration of CO<sub>2</sub> in the flue gas of a natural-gas-fired combined cycle is around 4% (by volume); it is higher, at around 14% for a coal-fired plant; and ranges up to 33% in the flue gas from a cement kiln. Separation of these large amounts of dilute CO<sub>2</sub> entails the addition of major items of equipment to a power station or industrial process (such as a cement kiln or steel furnace), which require significant quantities of energy for their operation.

Three main approaches have been developed to meet this challenge:

- **Post-combustion capture**, which minimises the modifications made to the combustion process and tackles the problem of separating large quantities of dilute CO<sub>2</sub> 'head on' by installing a separation process to treat the flue gas.
- **Oxy-combustion capture**, in which the volume of flue gas is reduced, and CO<sub>2</sub> concentration increased, by replacing air with oxygen for burning the fuel. And

- **Pre-combustion capture**, which avoids production of CO<sub>2</sub> in combustion by shifting the carbon based component of the fuel to hydrogen (which burns to water (H<sub>2</sub>O)), and separating the CO<sub>2</sub> before combustion when it is much more concentrated. An initial gasification step is needed if coal is the fuel.

Figure 3.1 illustrates the three options, together with capture for industrial processes. CO<sub>2</sub> capture from industrial processes may use one of three main approaches described or specific technological solutions tailored to the characteristics of the manufacturing process.

The following three sections discuss each of the three processes in turn, summarising their current status and anticipated developments. Sections 3.5 and 3.6 then examine the environmental impacts and costs of CO<sub>2</sub> capture. A final section draws together conclusions and recommendations. The main focus of this chapter is on the application of CO<sub>2</sub> capture to power generation, but some consideration is given to CO<sub>2</sub> capture for industrial processes at appropriate points in the text.

### 3.2 Post-combustion capture

#### 3.2.1 The basic process and application in power plants

In post-combustion capture (PCC), CO<sub>2</sub> is separated from the flue gas after a conventional combustion process. PCC can therefore be applied to newly built power plants or retrofitted to existing plants, both coal and gas fired.

Figure 3.1 Overview of CO<sub>2</sub> capture processes and systems. Adapted from IPCC, 2005.

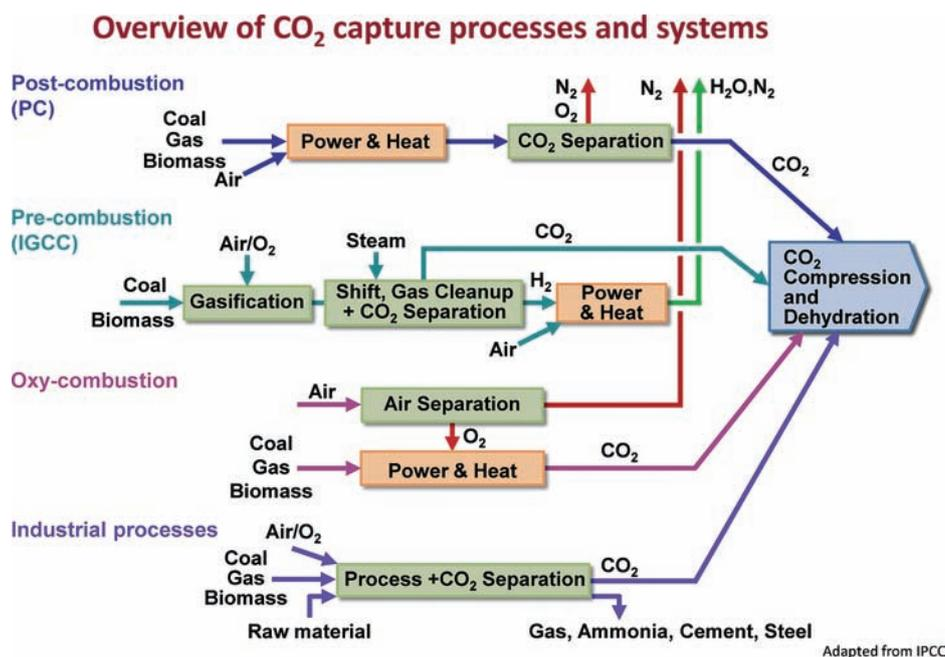

The PCC unit is added to the flue gas train after the conventional flue gas treatment equipment. One of the most important differences between coal and gas fired plants in respect of PCC is the concentration of CO<sub>2</sub> in the flue gas, being much more dilute in the latter. PCC can easily be adapted to account for these differences, although costs of capture increase with the level of dilution. It is also anticipated that it can be adapted to variable load operation of the power plant, which will become increasingly important in the future, although this remains to be demonstrated at commercial scale.

Reactive absorption is the most mature technology for PCC because vast experience exists with that technology for natural gas cleaning as well as for cleaning process gas streams in the chemical industry. A flow sheet of the basic process is shown in Figure 3.2.

In this process, the flue gas and the solvent flow counter-currently through the absorber column, typically equipped with structured or random packing to provide a large contact area, and CO<sub>2</sub> is absorbed and reacts with the solvent. The reaction accelerates the absorption process and leads to a high capacity of the solvent. The solvent is then regenerated in the desorber column at elevated temperature. Desorption requires heat which is supplied to the desorber by the evaporator. The evaporator is usually heated by means of steam. In power plant applications this steam stems from the power plant process and cannot be used for producing electricity, so the overall thermal efficiency of the power plant drops, typically by 7–13% (see Table 3.1). This is an important penalty. A retrofit of existing plants is only attractive if the efficiency without PCC is high enough (above 35% in IEA Greenhouse Gas R&D Programme (2011b)).

Typical CO<sub>2</sub> removal rates achieved in PCC are around 90%. Designing PCC for lower removal rates normally does not substantially reduce the capture cost and is

Figure 3.2 Basic flow sheet of a PCC absorption/desorption process.

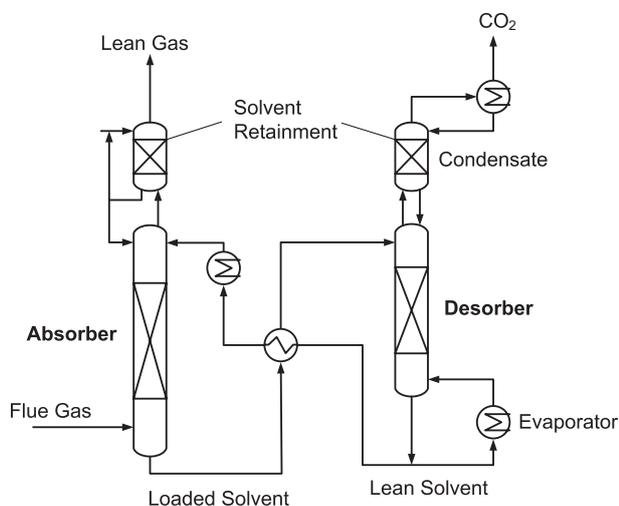

therefore not attractive. Higher removal rates are feasible, but only if higher efficiency penalties are accepted. To reduce emissions of the solvent, washing sections are used at the top of the columns. The CO<sub>2</sub> obtained at the top of the desorber basically contains only some water, typically at a partial pressure of around 30 millibars (depending on the temperature of the condenser at the top of the adsorber). Similar absorption/desorption processes have successfully been used for producing food grade CO<sub>2</sub> from flue gases.

### 3.2.2 Solvents

The most widely studied solvent for CO<sub>2</sub> removal from gas streams is a 0.3 g/g aqueous solution of monoethanolamine. Fluor is licensing a process based on this solvent which has been in use in 25 commercial installations in various application fields (Reddy et al., 2008). For CCS, however, the required dimensions are much larger than in those applications. Thus, reliable scale-up is a major issue. Furthermore, more oxygen is present in the PCC flue gas compared with other applications, leading to more problems with degradation of the solvent, which can, however, be solved using adequate corrosion inhibitors (Reddy et al., 2008).

The main drawback of the monoethanolamine technology is the high energy demand for the regeneration of the solvent. Furthermore, emissions of the solvent and its degradation products need to be considered. To overcome these disadvantages, a focus of past and current research is the development of new solvent formulations for PCC. Alternative aqueous amine solutions often use a base amine to provide basicity and an activator to enhance the kinetics. Sterically hindered amines such as aminomethylpropanol are often used as the base amine. Examples of such new aqueous amine systems include Mitsubishi's KS1 and KS2 solvents (IPCC, 2005; Mitchell, 2008) and BASF's OASE blue (GUSTAV200) (Moser et al., 2011). These solvents have been tested successfully in pilot plants of relevant design and scale, and are ready for scale-up to demonstration size.

Alstom has developed a process called the chilled ammonia process, which uses ammonia as the solvent and operates at temperatures below 20 °C in the absorber to keep ammonia emissions at an acceptable level. The process can be operated under conditions such that solids form, which may reduce the regeneration energy requirements (Raynal et al., 2011). Even though chilling is necessary, Alstom claims a lower energy demand than organic amine-based processes (Kozak et al., 2009). This technology has been tested in large-scale pilot plants (Telikapalli et al., 2011). Siemens has developed a technology called PostCap using an amino acid salt with a lower energy demand and lower solvent emissions than amine solutions (Jockenhoovel et al., 2009). Activated potassium carbonate is widely used to

remove CO<sub>2</sub> from industrial gas streams (the Benfield process), and has been suggested as a solvent for post-combustion capture. The Cooperative Research Centre for Greenhouse Gas Technologies (CO<sub>2</sub>CRC) is currently developing a low-cost process called UNO MK3 based on precipitating activated potassium carbonate (Hooper, 2012).

PCC using reactive absorption is a mature technology, and many hours of testing in various pilot plants operating directly on a slip stream of a power plant have been undertaken (see, for example, Moser et al. 2011; Knudsen et al. 2011). The scale-up from these pilot plants to large-scale applications is currently being realised in several demonstration projects.

### 3.2.3 Process modifications

Many modifications to the basic process of reactive absorption/desorption shown in Figure 3.2 have been suggested, and their feasibility and efficiency have been demonstrated. The most important of them are absorber intercooling (Reddy et al., 2008), lean vapour compression (Reddy et al., 2008) and split flow configuration (Reddy et al., 2003). Also, other options for optimisation such as increasing desorber pressure have been studied (JPC Corp. and BASF SE, 2012; Liebenthal et al., 2011).

### 3.2.4 PCC in manufacturing industries

The main focus of CCS research in the past has been on its application to power plants. To reduce worldwide CO<sub>2</sub> emissions, however, CCS should be applied not only to power plants but also to other large point sources of CO<sub>2</sub>, for example in the cement, steel and refinery industries.

It is expected that PCC can be retrofitted to existing cement plants, although it may not be the lowest cost option (IEA Greenhouse Gas R&D Programme, 2008b). The flue gas from cement production typically has a relatively high CO<sub>2</sub> concentration (up to 33% by volume of dry gas compared with 14% for a coal-fired power plant), resulting in an easier separation (ECRA, 2009; Carbon Sequestration Leadership Forum, 2009). The application of PCC to the cement industry is currently being investigated in various research projects (Mott MacDonald, 2010). The required energy for the re-boiler in the desorber, however, cannot be extracted completely from the cement kiln itself (ECRA, 2009).

In the refinery industry, process heaters, utilities, fluid catalytic crackers and hydrogen production are the main point sources of CO<sub>2</sub>, and PCC is the method of choice for capturing CO<sub>2</sub> for the near future (Det Norske Veritas, 2010), although oxy-firing of process heaters may be a more economical technical solution in the longer term. PCC can, to some extent, be applied in steel manufacturing as well. However, there are many different CO<sub>2</sub> sources at a steel mill and several stacks,

making it technically and economically very challenging to achieve near-zero emissions using PCC only (Arasto et al., 2012). Because part of the CO<sub>2</sub> emissions from steel manufacturing originates from the reduction of iron ore using carbon, different concepts are required and are being developed for the steel industry, such as top gas recycling blast furnaces and direct reduction processes that allow for more efficient integration of CCS (ArcelorMittal, 2010).

In all applications, the choice of the optimal solvent for PCC will depend mainly on the CO<sub>2</sub> partial pressure in the flue gas. For low CO<sub>2</sub> partial pressures, primary and tertiary amines or ammonia will be used, whereas for higher CO<sub>2</sub> partial pressures tertiary amines such as methyldiethanolamine (MDEA, often activated by a promoter such as BASF's aMDEA<sup>®</sup>), potassium carbonate (hot potash process) or physical solvents such as sulfolane become attractive. The technology options for CCS deployment in industrial applications are summarised in a report by IEA and UNIDO (IEA, 2011a).

### 3.2.5 Demonstration plants

The next step towards commercial deployment of CCS is the building of demonstration plants at the 200–300 MW<sub>e</sub> scale to demonstrate the integrated operation and performance of the power/industrial plant and CO<sub>2</sub> capture technology, and to reduce the risks of scale-up to commercial operation. Of the six demonstration projects that were selected by the European Energy Programme for Recovery, three were planned to demonstrate PCC using reactive absorption (European Commission, 2010a). Worldwide in 2011, 16 demonstration projects (capture and storage) were planned using PCC in the power sector and one, Boundary Dam in Canada, is currently under construction (GCSSI, 2011c) with a fully operational plant expected by mid-2013.

Demonstration plants should be set up to accommodate a range of solvents and should be shared by several companies, such as at the Technology Centre Mongstad in Norway ([www.tcnda.com](http://www.tcnda.com)). This should be a requirement of public funding schemes. One focus of the projects should be on the emissions of such plants. Besides the direct emissions from the stack, the atmospheric fate of the amines and their degradation products and their influence on soil, onshore water and the marine environment need to be studied in detail in the near future, with a special focus on the formation and environmental fate of possibly carcinogenic compounds such as nitrosamines.

Another important role for the demonstration plants will be to test variable load operation, which will be a key issue for PCC operation as the percentage of base load fossil-fired power generation in Europe's electricity system is expected to drop. Variable load operation of PCC is considered feasible but may lead to varying capture

rates (lower or higher) and increased cost per tonne of captured CO<sub>2</sub>. Variable load operation can be studied and optimised by computer simulations, but field studies are important to validate the results.

### 3.2.6 Expected improvements

As PCC is a feasible and fairly mature process, efforts for improvements focus on reducing the capital and operating costs of the plants. Capital cost reductions could be realised, for example, through less expensive construction materials like glass-fibre-reinforced plastic, or concrete with a polypropylene liner, or through less expensive column packings. Operating cost reductions could be achieved through more efficient solvents, column packings with lower pressure drop and further process modifications for increased energy efficiency. Such process modifications should be evaluated beforehand through model-based process simulations. For reliable simulations, sound experimental data (e.g. gas solubility data at various temperatures, heat of absorption, etc.) are necessary and the models have to be carefully validated against pilot plant data. Process models are also needed for a better understanding of the process in general, for scale-up, and studies of stationary and variable load operation, troubleshooting and training of staff.

In the near term, improvements to PCC could come from new, more efficient solvents. Much work has already been invested in the search for such solvents, which has led to substantial progress along the learning curve. In recent years, the specific energy consumption of the PCC process has decreased from about 4.2 gigajoules per tonne (GJ/t) CO<sub>2</sub> to 2.8 GJ/t CO<sub>2</sub>, i.e. by about 33%. Even though the limit may not yet be reached, further progress will be increasingly difficult to obtain with established technology, and may be only incremental.

An option could be phase-split solvents (e.g. DMX solvent by IFP Energies Nouvelles). In this process, the rich solvent shows a liquid-liquid phase split, with one phase rich in CO<sub>2</sub> which is sent to the desorber, and one phase poor in CO<sub>2</sub> which is directly recirculated to the absorber. IFP Energies Nouvelles claims a possible reboiler energy reduction to 2.1 GJ/t CO<sub>2</sub> (Raynal et al., 2011). Phase-change solvents are also currently being investigated within the EU project i-CAP (iCAP, 2012).

Possible problems with commercial operation of PCC plants include the dynamic operation of the power plants, requiring further experimental and model-based research into the load-following capabilities of PCC plants, and the optimal control strategies for such plants. For amine absorbents, corrosion and degradation are also of concern, but corrosion can generally be kept within acceptable limits, for example by corrosion inhibitors, which will also mitigate the degradation problem to a certain extent. For the deployment of CCS in dry regions, for example in Australia, cooling technologies such as air

cooling rather than water cooling may have to be applied (Tenaska Trailblazer Partners LLC, 2011).

Longer-term developments, potentially finding commercial applications towards 2050, include the following.

- **Adsorption processes.** A possible alternative to absorption processes for PCC is adsorption, either in fixed beds operated in cycles (as already commercially employed, for example, for CO<sub>2</sub> separation from syngas) or in fluidised beds. A very promising example of the latter is carbonate looping where calcium oxide (CaO) is converted to calcium carbonate (CaCO<sub>3</sub>) in a carbonator at temperatures of around 650 °C and recovered in a calciner at temperatures of around 900 °C, releasing CO<sub>2</sub>. As a raw material, cheap natural limestone could be used. A 1 GW<sub>e</sub> power station would entail a CaO/CaCO<sub>3</sub> circulation of 5000–16000 t/h (Epple and Ströhle 2008; Diego et al., 2012). Fresh limestone top-up will be required because of attrition and deactivation: rates are currently uncertain, but based on one estimate for a lignite plant (Vorrias et al., 2013), they could be around 200 t/h for a 1 GW<sub>e</sub> power plant.

With this process, higher energy efficiency than with amine scrubbing can be expected as the heat of the reaction is released at a high temperature level and can thus be used for electricity generation (Epple and Ströhle, 2011). Another advantage is that there are no problems with potentially harmful emissions. However, the technology still suffers from problems of attrition and sintering of pores in the particles, which reduce the lifetime of the adsorbent.

New adsorbents could also significantly improve fixed-bed processes compared with the currently used sorbents (zeolites, activated carbon). The regeneration of the loaded bed could either be accomplished through temperature change (temperature swing adsorption), pressure change (pressure swing adsorption) or the application of an electrical field (electrical swing adsorption). Examples of novel adsorbents are metal organic frameworks (Li, 2011; Britt et al., 2009), and amine-functionalised solids. However, it is currently unclear whether these technologies can be adapted to the needs of the very large-scale operation in PCC.

- **Membrane processes.** Another option for PCC is separation with membranes. The membranes have to exhibit a high CO<sub>2</sub> selectivity and permeability, have good thermal, chemical and mechanical stability in the flue gas conditions, and must be cost-effective (Follmann et al., 2011). Polymeric membranes, especially poly-phenylene oxide or poly-ethylene oxide membranes, are currently judged to be the most promising candidates for PCC. The driving force

will have to be generated by a combination of flue gas compression and permeate suction. PCC with membranes has already been tested in pilot plants, for example at MTR Inc (Menlo Park, California, USA) (Wessling, 2011).

Some authors, for example Zhao et al. (2009) and Ho (2008), claim that costs for membrane gas separation are comparable to PCC with amines. In the future, the development of new membrane materials with increased stability, enhanced resistance to high temperatures, plus increased permeability and selectivity, should be the focus of research.

- **Ionic liquids.** Ionic liquids have been discussed as solvents for CO<sub>2</sub> absorption in PCC. They have the advantage of extremely low vapour pressure and thus no emissions, except of possible degradation products. It is, however, not evident that they have the potential to reduce the energy penalty compared with other solvents. A disadvantage of most ionic liquids is their high viscosity, leading to very slow kinetics. So far no ionic liquid with a cyclic capacity similar to monoethanolamine has been identified. Also, other characteristics of ionic liquids such as corrosivity and toxicity are not sufficiently known yet (Karadas et al., 2010).
- **Hydrate formation.** The capture of CO<sub>2</sub> by the formation of hydrates, also known as clathrates, is also currently discussed: the potential advantage being regeneration at room temperature and high pressure (Herri, 2011; Raynal et al., 2011). For the formation of the hydrates, however, pressurisation of the flue gas to 10–20 bar and cooling to about 5 °C is necessary. With the help of promoters such as tetra-*n*-butyl ammonium bromide, the necessary pressure can be lowered. The applicability of such processes to large-scale PCC is still very speculative.

### 3.3 Oxy-combustion capture

Oxy-combustion to provide a CO<sub>2</sub>-rich flue gas for enhanced oil recovery was proposed in 1982 (Abraham et al., 1982). Since the beginning of the 1990s, and derived from the need to reduce CO<sub>2</sub> emissions from power generation and from industry, several institutions and companies in Europe, USA, Canada and Japan have performed pilot-scale studies. Oxy-combustion technology for coal-fired power generation is currently undergoing rapid development towards commercialisation with several pilot plants and demonstration projects starting or underway (Wall and Yu, 2009). However, as with application of other CCS technologies to power plants, oxy-combustion has yet to be deployed in commercial applications.

#### 3.3.1 The oxy-combustion process

During oxy-combustion, a combination of oxygen, with a purity of more than 95% by volume, and recycled flue gas is used for combusting the fuel, producing a gas consisting mainly of CO<sub>2</sub> and H<sub>2</sub>O which, after flue gas treatment, purification, de-watering and compression, is ready for transport and storage. Figure 3.3 shows the main components of an oxy-combustion pulverised coal power plant, which requires the supply of oxygen by a cryogenic air separation process, which is the only commercially available mature technology.

The separation of oxygen from air, as well as the purification and compression of the CO<sub>2</sub>-enriched flue gas, consume substantial amounts of auxiliary power. Therefore, the overall net efficiency is expected to be decreased by 7–12%, corresponding to a 17–35% increase in fuel consumption compared with conventional air combustion without CO<sub>2</sub> capture. This implies that oxy-combustion (and PCC) should be coupled with supercritical or ultra-supercritical steam cycles to provide acceptable net generating efficiencies. In addition, major

Figure 3.3 Schematic of a pulverised coal oxy-combustion power plant.

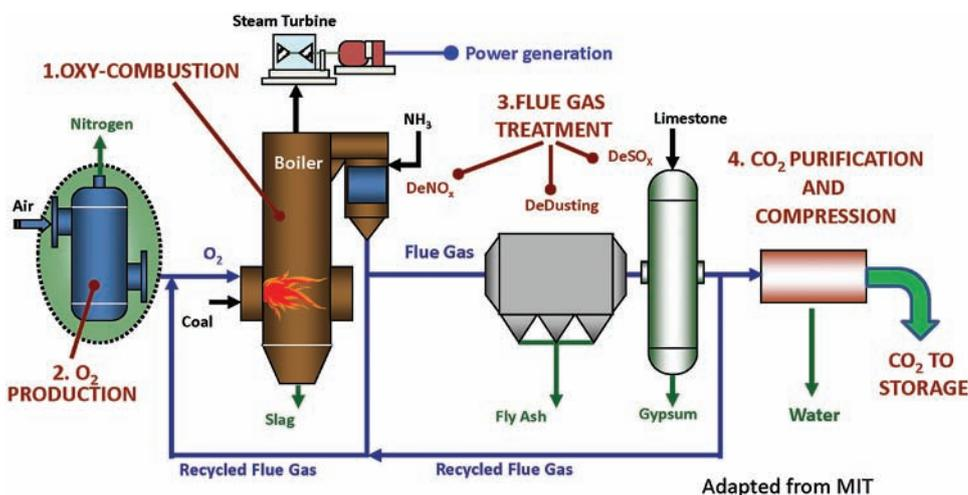

efforts are currently underway to reduce the energy penalty associated with oxygen production.

Fundamentally, because of the variation in the in-furnace gas environment compared with conventional air-fired combustion, oxy-combustion affects the combustion process as well as the related processes such as heat transfer (Scheffknecht et al., 2011). Numerous studies and research projects have been performed that provide scientific and engineering support to the large integrated pilots in operation in Germany (Vattenfall, pulverised coal), Spain (Ciuden, both pulverised coal and circulating fluidised bed) and France (Total, natural gas). Retrofitting performed by Callide in Australia should also provide some useful outcomes. Some results indicate that circulating fluidised bed boilers operating in oxy- mode could have some very attractive characteristics compared with pulverised coal boilers (Hack, 2011), including greater flexibility for biomass oxy-co-combustion.

Natural-gas-fired combined-cycle power plants, designed for CO<sub>2</sub> capture by oxy-combustion, use turbomachinery for the gas cycle designed to operate with thermodynamic and transport properties of CO<sub>2</sub>/steam mixtures in what is considered to be a challenging, novel engine development programme (the other part of the combined cycle, the steam Rankine cycle, is little changed). Characteristically, turbo-machinery speeds are reduced in CO<sub>2</sub> relative to air owing to differences in gas properties, which translates into lower power-plant output at synchronous speeds for heavy-duty machines (Dillon et al., 2004). Principal development requirements include combustion and materials technology and integration of system components in a power plant to demonstrate operability. Further long-term advances may include increased cycle pressure ratio with reheat, improved component efficiencies and advanced blade cooling using steam (Dillon et al., 2004; Anderson et al., 2008). Notwithstanding such potential process improvements, an inherent disadvantage of oxy-combustion for natural-gas-fired combined-cycle power plants is that 50% of the oxygen, and the energetic effort attached thereto, is used to generate water.

Gas impurities in an oxy-combustion flue gas are the same as in air fired combustion. Concentrations are higher, although emissions on a milligram per megajoule basis are lower. Primary in-furnace as well as conventional technologies exist for environmental pollution control, although they have yet to be applied to oxy-combustion at demonstration scale. These include fuel/oxidant stratification, low-NO<sub>x</sub> (oxides of nitrogen) burners, selective catalytic reduction and selective non-catalytic reduction for NO<sub>x</sub> removal, in-furnace limestone injection and wet flue-gas desulphurisation for desulphurization, and activated carbon beds for mercury, among others.

CO<sub>2</sub>-rich flue gas must be further processed to reduce water content and impurities drastically to

reach concentration levels compatible with transport and geological storage requirements. Competing technologies are under development with the aims of maximising heat integration, achieving so-called sour gas compression (processing 'raw' fuel gas without previous cleaning except for particulates) and optimising capture efficiency (Global CCS Institute, 2012b).

Oxy-combustion power plants should be able to deploy conventional, well-developed, high-efficiency steam cycles without the need to remove significant quantities of steam from the cycle for CO<sub>2</sub> capture, as is the case for PCC. The added process equipment consists largely of rotating equipment and heat exchangers: equipment familiar to power plant operators. New chemical operations are mostly restricted to some novel configurations of the CO<sub>2</sub> compression and purification units, currently under development. As a consequence, no significant on-site chemical inventory is required. Ultra-low emissions of conventional pollutants can be achieved, largely as a fortuitous result of the CO<sub>2</sub> purification processes selected, and at little or no additional cost (Global CCS Institute, 2012c).

Nevertheless, there are some important technological challenges for the demonstration of oxy-combustion power plants. It is not possible to develop sub-scale oxy-combustion technology at existing power plants. An oxy-combustion power plant is an integrated plant, and technology development will require commitment of the whole power plant. Thus, the technology development path for oxy-combustion may be more costly than that for either pre-combustion or post-combustion capture, which can be developed on slip streams of existing plants.

Air-fired combustion is commonly anticipated for start-up of oxy-combustion power plants. The very low emissions achieved by oxy-combustion with CO<sub>2</sub> purification cannot be achieved during air-fired start-up operations without specific flue gas treatment for air-fired operations that are redundant during steady state oxy-fired operations. If a significant number of annual restarts are specified, additional flue gas cleaning equipment will be required (at additional capital cost) particularly for pulverised coal boilers, although probably not for fluidised bed boilers. If boilers are designed for operation in both air and oxy-modes and the power plant is able to comply with environmental regulations in any condition, malfunctioning of the downstream steps for CCS (transport and storage), will not compromise power generation, although the value of required CO<sub>2</sub> EU allowances must be added to the cost.

A development issue for oxy-combustion power plants is their ability to ramp up and down at rates consistent with variable load operation. Whereas boilers typically have a ramp up rate of 4–5% per minute, air separation ramp up rates with current technology are substantially slower at around 3% per minute (IEA Greenhouse gas R&D Programme, 2012a).

### 3.3.2 Oxy-combustion capture in manufacturing industry

Application of CO<sub>2</sub> capture by oxy-combustion to other carbon-intensive industrial sectors is currently in the very early stages of development (Kuramochi, 2012). In general, industry lags power generation in this respect.

For refineries, some preliminary pilot results indicate that stable operation of an oxy-fuel fluid catalytic cracking plant without significant impact on catalyst regeneration and activity is technically possible. For retrofitting furnaces and heaters for oxy-fuel combustion, it has been suggested that the conversion of heaters may encounter more technical issues than boilers.

The cement sector does not see oxy-combustion as a priority as major redesign challenges for the clinker kiln and/or pre-calciner have to be faced. Oxy-combustion is more readily applied to the preheaters and pre-calciner of a cement plant (where most of the CO<sub>2</sub> is released) than to the kiln, but is not yet technically mature enough for deployment. It may, in time, offer a lower cost solution for new cement plants than post-combustion capture (IEA Greenhouse Gas R&D Programme, 2008a).

As discussed for PCC above, the iron and steel industries will require specific capture alternatives tailored to process characteristics. In the short to mid-term, process modifications integrated with chemical/physical absorption seem to be the preferred choice (IEA and UNIDO, 2011a). In Europe, 48 companies and organisations, from 15 countries, have launched a cooperative R&D project under the Ultra-Low CO<sub>2</sub> Steelmaking (ULCOS) consortium.

### 3.3.3 Expected improvements

Oxy-combustion technology is approaching the demonstration stage of development for power generation (Wall et al., 2011), and has been piloted at the Compostilla project in Spain ([www.compostillaproject.eu](http://www.compostillaproject.eu)). Technical uncertainties to be elucidated in the near term are largely associated with demonstrating reliability, efficiency and integration at industrial scale. Oxy-combustion technology for power generation is disadvantaged by its scale. 'Learning-by-doing' requires several commercial-scale plants, thus resulting in a high cost of demonstrating the technology at scale.

A second-generation oxy-combustion plant will probably include a combination of non-cryogenic O<sub>2</sub> supply, using either membranes of oxygen-capturing solids, to reduce specific energy consumption from today's range (160–220 kWh/t) down to 90–120 kWh/t, boiler design optimised for higher O<sub>2</sub> concentration and thus reduced flue gas recirculation, advanced heat integration, a compression and purification unit compatible with simplified flue gas cleaning train, and vent gas treatment (membranes) for higher CO<sub>2</sub> capture efficiency. This treatment could eventually increase current CO<sub>2</sub> capture efficiency of about 90–95%. Practically

all the above-mentioned developments are currently at pilot scale, with excellent prospects for some of them.

Medium-term advances are likely to be based on second-generation technologies currently at pilot scale. In chemical looping combustion, the separation of oxygen from air is integrated with fuel oxidation: the fuel does not contact the air directly, but a solid oxygen carrier material in a fuel reactor, which has been oxidised in a separate reactor. The inherent CO<sub>2</sub> capture of chemical looping combustion avoids the energy penalty of other competing technologies. Most of the experience so far has been gained with gaseous fuels where a promising point has been reached in the development of the oxygen-carriers. For chemical looping combustion for solid fuels, particularly coal, direct combustion of coal is being investigated to avoid the need for a previous coal gasification stage and its associated gaseous oxygen supply, an approach followed in early investigations. *In situ* gasification of coal in the fuel reactor using cheap oxygen carriers, such as natural minerals or industrial waste products, is promising. Processes for solid fuel combustion using oxygen carriers that can release oxygen at high temperature are another promising alternative (Adanez, 2012). The operation of a 1 MW<sub>th</sub> (megawatt thermal) chemical looping combustion plant with coal is currently underway, and plans for construction of a 10 MW<sub>th</sub> unit are under discussion.

Carbonate looping is receiving increasing attention from the CCS community. Pilots started up at La Pereda, Spain and at the TU Darmstadt in Germany have demonstrated excellent performance prospects for the technology, in particular regarding energy penalties which could be competitive with other second-generation technologies.

In oxygen transport membranes, as in chemical looping combustion, separation of oxygen from air is integrated with fuel oxidation. Important efforts are currently underway on materials and reactor development, reactor temperature control, etc., with the aim of making oxygen transport membranes an economical alternative to other proposed approaches. If the challenges can be solved at an acceptable cost, commercial-scale implementation should occur in the medium term (Quintrell and Foster, 2011).

Long-term advances are likely to be based on approaches that today are in early or very early stages of development derived from experimental work at laboratory scale. These include novel pressurised combustion concepts (dry or wet coal feed) able to produce a concentrated, pressurised CO<sub>2</sub> stream, for which engineering and economic analyses of the technologies are being undertaken over the period 2012–2013 (US Department of Energy, 2012b).

## 3.4 Pre-combustion capture

### 3.4.1 Process description

Pre-combustion CO<sub>2</sub> capture is mainly applied in integrated gasification combined-cycle (IGCC) power

plants. Coal is usually used as the fuel in such power plants. It is gasified with pure oxygen or air before combustion. It is also possible to use other solid fuels, for example biomass and petroleum residues, as the energy source. The gasification process results in the production of a mixture of hydrogen (H<sub>2</sub>), CO<sub>2</sub>, carbon monoxide (CO), H<sub>2</sub>O, nitrogen (N<sub>2</sub>), sulphur components and other trace impurities depending on the initial feedstock: so called 'syngas'. This syngas is obtained at high pressure (30–50 bar, depending on the gasifier), which makes subsequent purification and separation processes easier. In the case of CCS, the gases are further processed in a water gas shift reactor to react the remaining CO with H<sub>2</sub>O to form CO<sub>2</sub> and H<sub>2</sub> before CO<sub>2</sub> capture takes place. Sulphur removal is conducted either before the water gas shift (sweet shift), or afterwards together with the CO<sub>2</sub> capture (sour shift). The remaining H<sub>2</sub>-rich gas is used in the gas turbine for electricity generation.

### 3.4.2 Retrofit possibility

In principle it is possible to retrofit an existing IGCC plant with CO<sub>2</sub> capture. However, some points have to be considered, as follows.

- The gas turbine has to be able to burn highly concentrated H<sub>2</sub>. If this is not the case, the H<sub>2</sub> stream can possibly be diluted with N<sub>2</sub> or H<sub>2</sub>O.
- Less syngas energy is delivered to the power block (owing to the water gas shift reaction) or more syngas has to be produced to load the gas turbine fully.
- Several additional units have to be added: water gas shift reactor and increased acid gas removal capacity (for CO<sub>2</sub> capture) or a different CO<sub>2</sub> removal unit, but also additional air separation, gasification and gas clean-up capacity for increased syngas generation (as identified in the preceding point). If planned from the beginning, this oversizing could be included in the initial IGCC investment to allow the gas turbine to be run at full load after addition of CO<sub>2</sub> capture.

Overall, an IGCC power plant without CCS has high investment costs, and risks of outage are perceived to be higher than for conventional pulverised fuel plants. Therefore, not many IGCC power plants are in operation at the moment and the technology will probably only reach breakthrough in combination with CCS, hence retrofit is not an important option.

### 3.4.3 Advantages of IGCC plants with capture

Whereas IGCC power plants without CCS suffer from a low efficiency (38–43% compared with modern

pulverised coal plants with efficiencies of around 44%) and high investment costs, the conditions of the capture step, namely an elevated pressure, high CO<sub>2</sub> mole fraction (especially in the case of gasification with pure O<sub>2</sub>), and smaller volumetric gas flows compared with post-combustion capture, are advantageous for CO<sub>2</sub> separation. This leads to lower investment costs of the capture plant (owing to smaller flows) and a smaller efficiency loss due to CO<sub>2</sub> capture. Whereas the efficiency decrease due to CO<sub>2</sub> capture for pulverised coal plants is expected to be around 7–13%, for IGCC this value is estimated to be 6–10%. Additionally, IGCC plants have lower emissions of sulphur, mercury and particulates than pulverised coal plants. A further potential advantage is the possibility of simultaneously producing H<sub>2</sub> and/or syngas alongside electricity, where the syngas can be used to produce synthetic fuels, synthetic natural gas or base chemicals such as methanol or ammonia.

### 3.4.4 Capture technologies

There are several possible processes that can be used for the CO<sub>2</sub> capture step for IGCC. In principle these are absorption- and adsorption-based processes, membrane processes, cryogenic distillation or combinations of several of these processes. In the case of pre-combustion capture, the separation process benefits from high pressure (30–50 bar) and CO<sub>2</sub> mole fraction (around 40% on a dry basis if pure O<sub>2</sub> is used for gasification), which enables the use of physical solvents or adsorbent materials compared with post-combustion capture where the CO<sub>2</sub> is more diluted and chemical solvents or sorbents are required. The advantage of physical solvents is that their regeneration is less energy intensive and hence the energy penalty of the separation step is reduced. Consequently, the energy penalty is largely controlled by the subsequent CO<sub>2</sub> compression for transportation and storage (apart from the air separation unit and water gas shift reactor). Physical absorption processes using liquid solvents for acid gas removal are already commercially available. The flow scheme for this process looks similar to that shown in Figure 3.1.

Apart from the process used for CO<sub>2</sub> separation, the air separation, gasification, shift, CO<sub>2</sub> compression and gas turbine technologies are also important factors that determine the efficiency of an IGCC power plant with CO<sub>2</sub> capture.

### 3.4.5 Development status

IGCC technology without capture, even if not widely applied, is commercially available and several IGCC plants are operating worldwide (in Puertollano, Spain; Buggenum, the Netherlands; Nakoso, Japan; Wabash River, Indiana, and Polk Power Station, Florida, USA). The pre-combustion CO<sub>2</sub> separation process using acid gas removal is commercially available as it is applied

in a similar way in natural gas processing, natural gas reforming and coal gasification. The biggest challenge remaining is the use of the gas turbine under high  $H_2$  concentration conditions. However, if applied today, dilution with  $N_2$  or  $H_2O$  is an option.

Nevertheless, process improvements are important to reduce the efficiency loss due to capture but also to improve the overall process efficiency, which in turn will reduce the amount of  $CO_2$  produced per megawatt hour and therefore the amount of  $CO_2$  that has to be captured per megawatt hour. In contrast to the maturity of the individual technologies that are used commercially in separate applications, the number of integrated pilot or demonstration projects is very limited:

- One example is the IGCC power plant in Puertollano, Spain where a 2% slip stream (corresponding to 14  $MW_{th}$ ) was used to test  $CO_2$  capture over a period from October 2010 to June 2011.
- Several IGCC plants with capture are in the planning phase (mainly in the USA and UK): the Kemper County IGCC power plant in Mississippi is furthest advanced and under construction with start-up planned for 2014. It is a coal-based, air-blown 582  $MW_e$  IGCC power plant, which will capture up to 3.5 million tonnes of  $CO_2$  per year for enhanced oil recovery.

Nonetheless, for the reasons given, pre-combustion capture within an IGCC is regarded as (near) commercial technology and, setting aside consideration of economics (discussed in section 3.6), could be applied today with the option to dilute the  $H_2$  before the gas turbine to avoid combustion of highly concentrated  $H_2$ .

As a next step, fully integrated demonstration on a commercial scale is very important and would be feasible based on the experience available today. This is especially important in the case of IGCC power plants with pre-combustion capture, as the individual technologies are already well known, as discussed, but process integration is essential and much more demanding than post-combustion capture.

### 3.4.6 Application to other industries

As discussed, in the case of pre-combustion capture most experience available today comes from the application of the individual technologies in other industries:

- Natural gas purification: acid gas removal using liquid solvents is commercially applied to separate  $CO_2$  and hydrogen sulphide ( $H_2S$ ) from the natural gas stream. The  $CO_2$  is mostly vented, but some projects use it for enhanced oil recovery, and in a limited number of others (for example, Sleipner and Snøhvit in Norway) it is sent to geological storage.
- Natural gas combined cycle power plants: applying the concept of pre-combustion capture to these power plants requires that the feed gas is converted first to a mixture of  $CO_2$  and  $H_2$  using steam methane reforming, autothermal reforming or partial oxidation followed by water gas shift reaction as already used in the production of hydrogen, ammonia or other chemicals. In these processes at the moment the  $CO_2$  is mostly vented but could also be further used or stored.
- Coal gasification (chemical industry): production of various chemicals e.g. ammonia, urea, methanol, etc.  $CO_2$  removal in this case is commercially available, applied to many plants worldwide.

This is a major difference compared with post-combustion capture or oxy-combustion processes, where the technologies are developed first mainly for power applications and only in a second step is application to other industries considered.

Pre-combustion capture technologies will not play an important role in the steel and cement industries as the conditions are more appropriate to post-combustion capture.

### 3.4.7 Expected Improvements

The key areas of research interest, which may lead to commercial application on timescales beyond 2030, address the main energy losses in an IGCC power plant with pre-combustion  $CO_2$  capture, namely the air separation unit, water gas shift reactor, gas cooling and  $CO_2$  separation. Additionally, research on gas turbine technologies (higher efficiencies and higher firing temperatures) as well as  $CO_2$  compression is important. More precisely, research directions and developments that are primarily discussed and for which the highest increases in efficiency are anticipated are as follows:

- Acid gas removal processes at higher temperatures to avoid cooling of the syngas after shift. However, this requires that all gas purification steps ( $CO_2$  and sulphur removal, but also removal of trace impurities like Cl, As, Hg, ...) are feasible at high temperature. A sulphur removal process operating at a temperature higher than 230 °C is under development using a zinc-oxide-based sorbent. Otherwise, high-temperature membrane processes are believed to be promising.
- Ion transport membranes for improved air separation with lower power demand.
- Improvement of shift catalysts to allow operation at lower steam/ $CO$  ratios, which is especially important for dry coal-fed gasifiers (less steam is required from the steam cycle for the water gas shift).

- Recovery of H<sub>2</sub> and CO<sub>2</sub> at higher pressures to avoid the energy penalty due to CO<sub>2</sub> compression. Chilled ammonia absorption, cryogenic distillation and absorption using new solvents or combinations, for instance with membranes, are discussed in this context.
- Adsorption and membrane processes are further away from commercial application than new absorption concepts. However, comparable adsorption processes, albeit at a somewhat smaller scale, are used in commercial applications for H<sub>2</sub> purification. Compared with absorption processes using liquid solvents, the advantage of adsorption processes is the use of solid sorbents, which are believed to be more stable and to generate less additional air pollution (because of degradation, etc.).
- One newer idea is to use cryogenic distillation for the separation of H<sub>2</sub> and CO<sub>2</sub> to exploit synergies with the cryogenic air separation for oxygen production.
- Improvements in compression concepts to reduce the energy penalty associated with CO<sub>2</sub> compression.
- Development of high firing temperature and larger gas turbines with higher efficiency. This will contribute largely to efficiency improvements of the overall IGCC technology. Siemens have estimated that about 5% in efficiency can be gained back.
- Development of gas turbine compressor designs that allow air extraction when firing H<sub>2</sub> to decrease the auxiliary load for the main air compressor for the air separation unit.
- Combination of several steps in one unit. One example is high-temperature metallic membranes with the possibility to include the shift catalyst and additional recovery of CO<sub>2</sub> at higher pressure. Another example for the combination of two process steps is the sorption-enhanced water-gas shift process, where hot, high-pressure H<sub>2</sub> is produced in a catalytic shift reactor with simultaneous CO<sub>2</sub> adsorption. The process operates in a cyclic manner, similar to a pressure swing adsorption process, using steam for the regeneration step.
- The replacement of gas turbines with fuel cells.

In a roadmap identified by the Electric Power Research Institute and the US Department of Energy, it is believed that IGCC technology developments will increase overall efficiencies at least to the level of current IGCC plants without capture (Global CCS Institute, 2012a).

### 3.5 Environmental impacts

An integrated life-cycle approach is needed to evaluate the environmental impacts of capture technologies so that effects occurring away from the actual physical site of CO<sub>2</sub> capture can also be properly considered. Besides CO<sub>2</sub> emissions, direct and indirect emissions of substances such as NO<sub>x</sub>, SO<sub>2</sub>, ammonia (NH<sub>3</sub>), volatile organic compounds and particulate matter have to be considered. Koornneef et al. (2010, 2011) provide a comprehensive review, and the European Environment Agency (2011a) has produced a report on air pollution impacts of CCS. This section concentrates on direct emissions arising from fuel combustion at power plants with CO<sub>2</sub> capture, and indirect emissions from the fuel and solvent chains.

Much of the information available in the literature concerning environmental impacts and, in particular, emissions of air pollutants from energy conversion technologies with CO<sub>2</sub> capture, is merely qualitative, most often based on assumptions and model predictions rather than on actual measurements. As a consequence, present work at large integrated pilots is of utmost importance to provide sound data derived from experimental work of industrial relevance. Conclusions from the references cited above must therefore be taken as preliminary, pending evaluation of results from the pilot plants.

In general terms, the addition of CO<sub>2</sub> capture technology to power plants leads to an energy penalty that varies depending on the capture technology applied. This energy penalty requires supplementary consumption of fuel and consequently results in possible additional direct and indirect emissions. Typical penalties on power generation efficiency associated with first-generation CO<sub>2</sub> capture processes are in the range 6–13%, so interest in process optimisation and in the research for advanced solutions is high from an environmental point of view.

Considering direct emissions to air, CO<sub>2</sub> capture at the power plant will yield CO<sub>2</sub> emissions reductions typically in the range 85–98%. Overall, and depending upon the type of CO<sub>2</sub> capture technology implemented, synergies and side effects are expected to occur with respect to the emissions of the main air pollutants NO<sub>x</sub>, SO<sub>2</sub> and particulate matter. Koornneef et al. (2010) have derived 'carbon capture quotients' (CCQs) as the ratio of emission factors for the main pollutants from fuel conversion technologies with and without CO<sub>2</sub> capture. The quotient indicates the relative increase or decrease in the emission factor (grams per kilowatt hour) of a substance owing to the application of a certain CO<sub>2</sub> capture technology. A value of 1.0 indicates no change in emission factor compared with a reference plant without CO<sub>2</sub> capture. Only direct emissions are considered in the calculation of the carbon capture quotients.

In Table 3.1, carbon capture quotients are shown for various combinations of energy conversion and CO<sub>2</sub> capture technologies. For the three capture technologies evaluated, quotients for NO<sub>x</sub>, SO<sub>2</sub> and particulate matter will reduce (in some cases drastically) or remain unchanged compared with emissions at facilities without CO<sub>2</sub> capture.

Emission limit values within the EU are expressed on a concentration basis (milligrams per normal cubic metre) corrected to a standardised oxygen content in flue gases. For plants incorporating some of the capture alternatives, this should be revised as the capture process might result in much reduced flue gas flow to the stack and therefore produce higher pollutant concentrations, although emissions are lower on an energy basis.

Indirect CO<sub>2</sub> emissions (and potentially air pollutant emissions) from upstream fuel extraction, preparation and transport cannot be captured, including the life-cycle emissions associated with the CO<sub>2</sub> transport and storage processes. Values are fuel- and country-specific. Average figures for CO<sub>2</sub> for Europe are around 140 and 80 grams of CO<sub>2</sub> equivalent per kilowatt hour for coal and natural gas, respectively. Indirect emissions could be lower in future if there are regulatory and/or economic incentives to reduce them and energy supplies such as electricity to upstream users are decarbonised.

In recent times, some concerns have been expressed about the effects of amine emissions and degradation products such as nitrosamines, nitramines, aldehydes and amides on the basis of a study conducted in 2008 by the Norwegian Institute for Air Research. Since then, several practical R&D projects have been actively investigating species formation, emission and countermeasures, subsequent effects in the atmosphere, dispersion and deposition phenomena, and impacts on health and the environment. A detailed study from the IEA Greenhouse Gas Programme (2012b) provides a valuable contribution on this issue.

The emissions of the amines and especially some of the degradation products listed above can have negative effects on human health (irritation, sensitisation, carcinogenicity, genotoxicity) and on ecosystems (toxic to animals and aquatic organisms, eutrophication and acidification in marine environments). The risk of health impacts from nitrosamines should, however, be rather small as they are decomposed rapidly by light, resulting in an atmospheric residence time of around 1 hour (Shao and Stangeland, 2009; ZEP, 2012a). Nitramines are expected to have longer residence times, around 3 days, but are less potent as mutagens and carcinogens (ZEP, 2012a).

A range of countermeasures are available in the capture process to avoid the formation and emission of degradation products, but further research is needed to establish their effectiveness and to optimise their design and operation. The IEA Greenhouse Gas Programme report (2012b) suggests that the inclusion of an acid wash in the post-combustion capture process appears to offer a simple but robust catch-all solution to this emerging issue, although additional work needs to be done.

Other options to reduce emissions include high-efficiency demisters and filters, and ultraviolet treatment of lean amine, wash water and gaseous outlets, which may be able to reduce amine emissions to levels of a few parts per billion (Gjernes, 2013). These technologies will be evaluated at Test Center Mongstad, where emissions of amines and their degradation products (particularly nitrosamines and nitramines) will be closely monitored in the surrounding media (air, soil, moss, freshwater).

Further modelling of formation, deposition and degradation processes is also required, together with research to quantify better the health and safety impacts of degradation products under representative conditions (ZEP, 2012a). Alternatives to amines, such as ammonia, which avoid the amine degradation issue, have been discussed elsewhere in this chapter.

**Table 3.1 Average, minimum and maximum values for the carbon capture quotients determined for CO<sub>2</sub>, SO<sub>2</sub>, NO<sub>x</sub> and particulate matter for various combinations of energy conversion and CO<sub>2</sub> capture technologies (adapted from Koornneef et al., 2010)**

Capture technology	Capture technology	CCQ <sub>CO2</sub>	CCQ <sub>SO2</sub>	CCQ <sub>NOX</sub>	CCQ <sub>PM</sub>
Post-combustion	NGCC	0.13 (0.10–0.15)	–	1.00 (0.92–1.04)	–
	PC	0.10 (0.04–0.20)	0.15 (0.00–0.60)	0.94 (0.86–1.00)	0.71 (0.23–1.00)
Pre-combustion	IGCC	0.11 (0.09–0.15)	0.45 (0.07–0.85)	0.85 (0.76–0.96)	1.00 (0.99–1.01)
Oxyfuel combustion	NGCC	0.02 (0.00–0.03)	–	–	–
	PC	0.05 (0.00–0.14)	0.06	0.42 (0.00–1.00)	0.06 (0.00–0.13)

IGCC, integrated gasification combined cycle; NGCC, natural gas combined cycle; PC, pulverised coal.

The European Environment Agency (2011a) report also includes some interesting data relating to indirect emissions from solvent manufacture and treatment of solvent waste. For monoethanolamine, the report indicates that 75–85% of the emissions (NO<sub>x</sub>, SO<sub>2</sub> and non-methane volatile organic compounds, among others) originate from the raw material manufacturing. Monoethanolamine-based post-combustion capture results in 3.2 kg reclaimer sludge per tonne of CO<sub>2</sub> captured. Solvent sludge has to be treated as hazardous waste, for which the incineration is bound by strict regulations, resulting particularly in NO<sub>x</sub> and NH<sub>3</sub> emissions.

The use of water is a critical aspect of the design, engineering and operation of any fossil-fuel-fired power plant, and it is an important element in any environmental assessment. In power plants, water is used primarily for cooling and secondarily for operating environmental control systems as well as the CCS system. For power plants with conventional wet cooling towers, approximately 80% of total plant water withdrawals (water taken from a source and sent back to the same source) and 86% of plant water consumption (irrecoverable loss of water that is not returned to the source) is for cooling.

Common to all three capture alternatives is the associated energy penalty, which results in higher fuel consumption and a larger boiler duty to produce the same net electricity as a power plant without CCS. As a consequence, cooling water requirements and evaporative losses (when wet cooling towers are used) are larger on a basis of cubic metres per net megawatt hour of electricity.

Studies on water use of CCS power plants are scarce. The addition of an amine-based post-combustion system to a pulverised coal power plant has substantial effects on water use (Zhai, 2011). However, Santos (2011) concludes that although adding CO<sub>2</sub> capture significantly increases the water requirements of power plants, techniques can be used to reduce the water requirement to zero (for pulverised coal plants) or close to zero (for IGCC) if required. Water requirement is therefore not expected to be a constraint on the adoption of CO<sub>2</sub> capture technology (Santos, 2011).

Some impurities will be contained in the CO<sub>2</sub> stream transported to the storage site. Although they will vary between capture processes, all capture plants will have to be designed and operated to meet fairly strict limits on individual contaminants to ensure the safe and reliable operation of the transport and storage stages of CCS projects. These limits and issues are discussed in more detail in Chapter 4 on transport of CO<sub>2</sub>.

### 3.6 Costs

The cost of electricity generated by power plants with CCS strongly depends on the type of fuel, the site

location, the technology used both for the power plant and the capture process as well as on financial boundary conditions such as depreciation time, interest rate and especially on the fuel cost. The different assumptions for these quantities that are used in the available studies on the cost of CO<sub>2</sub> capture on power stations therefore make meaningful direct comparisons of numbers from different studies difficult.

The levelised cost of electricity (LCOE) is often used as a basis for comparison of different technologies for electricity production. It takes into consideration plant capital costs, operating and maintenance costs, fuel costs, site costs, and assumptions on financial data over the entire lifetime of the power plant to calculate the electricity cost without profit (ZEP, 2011b), averaged over the life of the plant. Care must be taken in using LCOE when comparing technologies because their ability to respond to electricity system requirements will differ and consequently so will the value of their generation to the electricity system. This is discussed further in Chapter 8.

In Table 3.2, the LCOE in euros per megawatt hour and the associated power plant net efficiency as a percentage of the lower heating value is shown for hard-coal power plants equipped with amine-based PCC, pre-combustion capture (IGCC) and oxy-combustion technology as well as for natural gas power plants equipped with amine-based PCC. Data from four different sources are presented, which are the following.

1. The report by ZEP (2011b) uses new or updated data provided by the industrial and utility members of ZEP, many of which have already undertaken detailed engineering studies for EU CCS demonstration projects. Two types of scenario are studied: a base plant (BASE) representing today's technological choices, and optimised power plant with CO<sub>2</sub> capture (OPTI) for an optimised, more ambitious design with technological improvements.
2. The data published by the IEA (2011) is the average cost from various previous studies (2005–2009) for the first commercial installations (expected then for about 2015) that were re-evaluated using consistent economic assumptions.
3. The cost study from the Global CCS Institute (2011d) uses published sources together with in-house databases from WorleyParsons and Schlumberger and other data from corporate, government and research stakeholders. Values for a first of a kind and an *n*th of a kind installation are given.
4. Alstom (2011) published results from an in-house cost study based on their CCS experience in 13 pilot plants and give values for 2015 as well as for 2030 obtained

assuming a conservative industrial learning curve as experienced with other technologies, and including fuel price projections.

In Table 3.2, only the cost of capture reported in these studies is considered. Costs for lignite fired power plants are not included in the present discussion but can be found in Alstom (2011) and ZEP (2011b).

The different sources in Table 3.2 show that there is currently no clear difference between any of the considered capture technologies in terms of cost. Thus, none of the technologies can be ruled out based on the economic expectations. The cost estimates for hard coal-fired power plants equipped with carbon capture technology range from €55 to €90/MWh for PCC, from €55 to €87/MWh for oxyfuel, and from €71 to €84/MWh for IGCC, which means an increase in the cost

of electricity production of €16–39/MWh (i.e. 31–81% higher than the generation cost without carbon capture).

The corresponding efficiency losses range from 7 to 13% for PCC, from 7 to 12% for oxy-combustion and from 6 to 13% for IGCC (referenced against a normal pulverised coal power plant). The data from the Global CCS Institute show the highest efficiency penalties whereas the studies by Alstom, IEA and ZEP show lower efficiency drops.

The large range of costs is caused not only by the different efficiency penalties but also by different fuel price assumptions, economic assumptions and differences in the base power plant technology, i.e. variation in cost for base power plants. The LCOE in North America is lower than in Europe mainly because of the lower fuel prices. Regarding PCC with amines for natural gas applications, there is a broad range of LCOE (€47–104/MWh), mainly

**Table 3.2 Levelised cost of electricity (LCOE) (excluding transport and storage) in euros per megawatt hour (€/MWh) and power-plant net efficiency as a percentage of lower heating value (LHV) for electricity generation from hard coal (bituminous coal) and natural gas from different sources (ZEP 2011b; IEA 2011c; Global CCS Institute R&D Programme 2011d; Alstom 2011)**

	Source	Region	Maturity	Hard coal				Natural gas	
				Base	PCC	Oxy-fuel	IGCC	Base	PCC
LCOE (€/MWh)	ZEP <sup>a</sup>	EUR	BASE	48	73	76–87	80	72 (47)	104 (74)
			OPTI	—	67	63–69	71	69 (46)	92 (64)
	IEA <sup>b</sup>	VAR	2015	50	81	77	79	58	77
	Global CCS Institute <sup>c</sup>	NAM	FOAK	53–55	82–90	77–82	84	64	83
			NOAK	53–55	79–88	75–81	82	64	82
	Alstom <sup>d</sup>	EUR	2015	49	80	75	—	43	60
			2030	50	69	68	—	42	50
	Alstom <sup>d</sup>	NAM	2015	38	65	61	—	42	53
			2030	39	55	55	—	40	47
	Net efficiency (% LHV)	ZEP	EUR	BASE	46	37	35	36	58
OPTI				46	39	36	40	60	52
IEA		VAR	2015	41	31	32	33	57	48
Global CCS Institute		NAM	FOAK	41–47	28–35	30–35	34	56	48
Alstom		EUR	2015	46	37	37	—	61	—
			2030	48	41	41	—	63	57
Alstom		NAM	2015	44	35	35	—	60	—
			2030	47	39	39	—	62	—

EUR, Europe; NAM, North America; VAR, various, mainly USA, few EU and China; FOAK, first of a kind; NOAK, *n*th of a kind.

<sup>a</sup>Fuel costs based on projections for the year 2020; only values from middle fuel cost scenario shown here (€2.4/GJ for hard coal and €8.0/GJ for natural gas); for natural gas also values for low fuel cost scenario (€4.5/GJ) in parentheses; for oxy-fuel a range is given owing to high uncertainty in costs; investment costs referenced to the second quarter of 2009 using cost indices.

<sup>b</sup>Average values from various cost studies (from the period 2007–2010) re-evaluated to a common costing background (to 2010 cost levels using cost indices); conversion from US dollars to euros with average yearly conversion rate for 2010 of €0.755 per US dollar.

<sup>c</sup>Range of values reflect different power plant technologies (ultrasupercritical–supercritical); conversion from dollars to euros with average first-quarter conversion rate for 2010 of €0.722 per US dollar; transport costs of €0.7/MWh and storage costs €4.3/MWh not included; conversion of efficiencies from higher to lower heating value with an estimated 5% difference for coal and 10% difference for natural gas according to IEA (2011b).

<sup>d</sup>Transport and storage costs subtracted from published values (€5.3/4.9/MWh in Europe and €6.6/6.1/MWh in North America for 2015/2030), base year for costs is 2010.

because of a high uncertainty in future gas prices (e.g. impact of shale gas) and a much higher sensitivity of LCOE to fuel price for natural gas power plants compared with coal power plants (IEA, 2011c). Alstom (2011) see a lower efficiency drop (of only 6%) compared with the other sources (8–10%) and correspondingly lower costs. All sources show that electricity from natural gas power plants with CCS can be competitive with electricity from coal power plants with CCS, depending on the relative prices of coal and natural gas.

ZEP (2011b) and Alstom (2011) agree that further expected improvements will lead to cost reductions (cf. values for OPTI and 2030) in the range of €5–10/MWh (corresponding to 10–20% of the base costs without capture). The Global CCS Institute (2011d) study envisages a smaller cost reduction (around €2/MWh or 4% of the base cost without capture) with process maturity (cf. first of a kind and *n*th of a kind) as most of the CO<sub>2</sub> capture capital costs is associated with proven and commercially available technology. Here, however, process improvements through new capture technologies (and the associated increase in efficiency) were not considered.

If one were so bold as to disregard all these important differences between the different studies and still try to give a rule of thumb for the expected increase of the price of the production of electricity due to the implementation of carbon capture technologies using the data shown in Table 3.2, the answer would be that all sources agree the increase will be of the order of 50%. In other words, we do not expect that the cost will double, but we also do not expect that it will only increase by one-quarter. Modest improvements are anticipated over the next 20 years resulting in this 50% 'ballpark' cost penalty potentially reducing to 30–45%. Further incremental improvements may be expected beyond that timescale, but improvements that are more substantial based on radically new technologies and configurations are speculative at the present time.

### 3.7 Conclusions and recommendations on capture

Carbon capture on fossil-fired power stations and industrial processes is technologically feasible, but integrated operation at commercial scale remains to be demonstrated. Key objectives of demonstration plants will be to confirm estimates of capital cost and operational performance, particularly efficiency, emissions, reliability and variable load operation.

There are three options for capture – post-combustion, pre-combustion and oxy-combustion – which have

different strengths and weaknesses, and at this point are anticipated to have broadly similar CO<sub>2</sub> capture and generating costs. A choice between them will depend on the specific parameters of the application.

For power generation applications, they result in an increase in the LCOE of the order of 50%. For all three technologies there are many developments in train which are intended to reduce this cost penalty, and which may bring this cost penalty down to 30–45% over the next 20 years. Further incremental improvements are projected beyond that timescale, but are difficult to predict.

These cost penalties mean that it is not currently economic to undertake CO<sub>2</sub> capture in the power generation and industrial markets given the prevailing electricity prices, which do not factor in the external costs of climate change. Capturing CO<sub>2</sub> will need to be much more highly valued than at present to incentivise the commercial deployment of CCS. In round terms, taking the mid-points of the data on the costs of avoiding the emission of a tonne of CO<sub>2</sub> presented in Chapter 8 (Table 8.1) through application of CCS, the price for EU allowances in the ETS would have to be around €50/t CO<sub>2</sub> to make carbon capture from coal-fired power plants economically attractive, and around twice that for gas-fired power plants: they are currently trading at around €8/t CO<sub>2</sub>. A price of €50/t CO<sub>2</sub> or more for coal-fired stations, and €100/t CO<sub>2</sub> for gas-fired stations, would have to be guaranteed over a long period to make investments attractive. Given the economic landscape and risk aversion of plant owners and operators, additional incentives and guarantees may also be required, as discussed in Chapter 8.

The proposed demonstration plants are a critical next step and need to be realised without delay, particularly as lead times for major new capital projects are long. To enable the sharing of knowledge obtained in these publically subsidised projects between companies and other stakeholders, the key results from the demonstration plants should be published. Demonstration plants should be set up to investigate a range of options, for example for solvents for CO<sub>2</sub> absorption. Such flexibility is likely to be more important in light of the reduced expectations for the number of demonstration plants to be built, as discussed in Chapter 8.

Modelling and simulation offer an efficient and cost-effective way of supporting pilot and demonstration plants, which can be used for model validation. Model-based optimisation has an important role to play.

## 4 Transporting CO<sub>2</sub>

This chapter first introduces the two main options for CO<sub>2</sub> transport – pipelines and ships – and then reviews their development status. Section 4.3 considers the key issues associated with developing Europe's CO<sub>2</sub> transport infrastructure before a summary of CO<sub>2</sub> transport costs is presented in section 4.4. Finally, key factors concerning CO<sub>2</sub> transport that will influence the progress of CCS in Europe are summarised in section 4.5.

### 4.1 Transport options

Although the main part of CO<sub>2</sub> transport between capture and storage is anticipated to be by pipelines, ship transport in specially designed tankers can be favoured in some circumstances (Global CCS Institute, 2011b; ZEP, 2011b):

- small and/or remote offshore storage facilities;
- low injection rates in offshore storage facilities; and
- during the start-up phase of CCS schemes when flexibility is at a premium.

Pipeline transport costs are largely determined by capital investment and are proportional to distance, whereas shipping costs are less sensitive to distance. Consequently, there is often a breakeven distance beyond which ship transport is cheaper than pipelines. Table 4.1 from ZEP (2011b) illustrates this effect. The calculated breakeven distance depends on study parameters and assumptions: ranging for offshore pipelines from 150 to 1500 km in studies reviewed by the IEA Greenhouse Gas R&D programme (2011a): Decarre et al. (2010), IEA Greenhouse Gas R&D programme (2004), Vermeulen (2011) and ZEP (2011b). Pipeline costs are sensitive to economies of scale and to capacity use (hence, breakeven distances at the higher end of the range are for larger capacity pipelines).

Combining pipelines and ships for offshore storage could provide cost-effective and lower-risk solutions, especially for the early developments of clusters and when, in initial stages, there are significant uncertainties about the capacity and injectivity of storage facilities. Ship transport may also be the preferred option for countries such as Finland, which are remote from storage capacity.

### 4.2 Development status

**Pipeline transport** of CO<sub>2</sub> is sometimes referred to as the most 'mature' component of CCS systems, thanks to the 6000 km of CO<sub>2</sub> pipelines in North America which have been used in connection with enhanced oil recovery

for up to 40 years (Energy Institute, 2010). However, although some useful lessons can be drawn from the North American experience, CO<sub>2</sub> transport in Europe will be through more challenging terrains (e.g. closer to urban centres and offshore), and will face higher levels of impurities and more variable rates of input (Element Energy, 2010; Bilio et al., 2009). A key consideration is to assure safety of pipeline operations, as a pipe rupture, although improbable, could quickly release large quantities of CO<sub>2</sub> and, under unfavourable circumstances (for example, where pooling of the CO<sub>2</sub> is possible), reach critical concentrations in the surrounding area. CO<sub>2</sub> is an asphyxiant and toxic at high concentrations, posing an immediate threat to life at volumetric concentrations in the air greater than 10–15% (Rice, 2004; Harper, 2011).

Operational challenges arise from the impurities contained in CO<sub>2</sub> streams (see Table 4.2), which will differ according to the capture technology. Impurities also affect pipeline mechanical integrity (potentially owing to hydrogen embrittlement, corrosion and hydrate formation) and can adversely impact on the hazard profile of the escaping CO<sub>2</sub>. They modify the CO<sub>2</sub> thermo-physical and phase equilibrium behaviour: experimental data need to be acquired, and equations of state developed and validated, to cover the range of conditions and CO<sub>2</sub> stream compositions likely to be encountered in transport pipelines.

It is cheaper to gather CO<sub>2</sub> from multiple sources and to transport the combined stream through trunk mains, rather than to have separate point-to-point transfer between each source and storage facility. The composition of CO<sub>2</sub> streams may vary between capture

**Table 4.1 Dependence of pipeline and ship costs on distance (ZEP, 2011b)**

<b>Demonstration scale: 2.5 Mt/year: point-to-point</b>				
Distance (km)	180	500	750	1500
Onshore pipe	5.4	n.a.	n.a.	n.a.
Offshore pipe	9.3	20.4	28.7	51.7
Ship (including liquefaction at €5.3/t CO <sub>2</sub> )	13.5	14.8	15.9	19.8
<b>Commercial large-scale network: 20 MT/year: spine + 2 feeders and distribution pipes</b>				
Distance (km)	180	500	750	1500
Onshore pipe	1.5	3.7	5.3	n.a.
Offshore pipe	3.4	6.0	8.2	16.3
Ship (including liquefaction at €5.3/t CO <sub>2</sub> )	11.1	12.2	13.2	16.1

Second quarter 2009 money values, excluding cost of compression from capture plant.

**Table 4.2 CO<sub>2</sub> quality recommendations from the DYNAMIS project (source: Ecofys, 2007)**

Component	Concentration	Limitation
H <sub>2</sub> O	500 parts per million	Technical: below solubility limit of H <sub>2</sub> O in CO <sub>2</sub> . No significant cross effect of H <sub>2</sub> O and H <sub>2</sub> S, cross effect of H <sub>2</sub> O and CH <sub>4</sub> is significant but within limits for water solubility
H <sub>2</sub> S	200 parts per million	Health and safety considerations
CO	2000 parts per million	Health and safety considerations
O <sub>2</sub>	Aquifer < 4 volume %, enhanced oil recovery 100–1000 parts per million	Technical: range for enhanced oil recovery because of lack of practical experiments on effects of O <sub>2</sub> underground. Also, the concentration of all non-condensable gases together (i.e. O <sub>2</sub> , CH <sub>4</sub> , N <sub>2</sub> , Ar and H <sub>2</sub> ) should not exceed 4 volume %.
CH <sub>4</sub>	Aquifer < 4 volume %, enhanced oil recovery < 2 volume %	As proposed in ENCAP project ( <a href="http://www.encapco2.org/">http://www.encapco2.org/</a> )
N <sub>2</sub>	< 4 volume % (all condensable gases)	As proposed in ENCAP project
Ar	< 4 volume % (all condensable gases)	As proposed in ENCAP project
H <sub>2</sub>	< 4 volume % (all condensable gases)	Further reduction of H <sub>2</sub> is recommended because of its energy content
SO <sub>x</sub>	100 parts per million	Health and safety considerations
NO <sub>x</sub>	100 parts per million	Health and safety considerations
CO <sub>2</sub>	> 95.5%	Balanced with other compounds in CO <sub>2</sub>

technologies, and cross-chemical reactions and effects may arise owing to the mixing of streams. Common entry specifications need to be developed for pressure, temperature and concentrations of impurities (Element Energy, 2010). Such specifications will reflect a trade-off between cost and operational considerations in the capture, transport and storage components of the CCS system. They may also impose limitations on the choice of capture, drying and compression technologies, and consequently on innovations in those technologies. An initial set of recommended specifications, reproduced in Table 4.2, was developed by the Dynamis project (Ecofys, 2007) based on transport considerations for a capture process on a plant co-producing electricity and hydrogen. It may be anticipated that further research, discussed below, and operational experience may lead to the revision and refinement of the specifications set out in Table 4.2.

Key R&D activities that need to be undertaken to establish a firmer basis for pipeline transport of CO<sub>2</sub> include the following.

- Establish maximum allowable levels of water, which could otherwise lead to the formation of hydrates (which could plug pipelines and/or heat exchangers), or to free water which could result in high corrosion rates of carbon steel pipes (corrosion resistant materials would increase pipeline costs by an order of magnitude (ZEP, 2011b)).
- Develop operational guidelines for variable load operation to avoid two-phase flow.

- Develop an improved experimental and theoretical basis to model leakage scenarios, together with leak mitigation/remediation techniques, leading to the establishment of best practice guidelines (see, for example, the CO<sub>2</sub>PipeHaz project (<http://www.co2pipehaz.eu/>)).
- Develop and validate models of pipeline fractures (including the potential for fast-running fractures), enabling the selection of appropriate materials and crack arrestor options (Mahgerefteh et al., 2012).
- Develop and validate models of CO<sub>2</sub> outflow and dispersion in the event of a pipeline rupture to enable the specification of safe distances to population centres and to inform emergency response planning.

Although transport is generally the lowest cost component of CCS systems, the large scale of transport infrastructures expected to be needed in Europe points to the value of reducing pipeline capital and operating costs: new, lighter pipeline materials, novel sealing and joining techniques and advanced CO<sub>2</sub> compression technologies are identified as potential opportunities (IEA, 2009; UK Advanced Power Generation Technology Forum, 2011).

It is considered that the **ship transport** of liquid CO<sub>2</sub> is 'proven' (IEA Greenhouse Gas R&D Programme, 2011a), but experience so far has been at small scale (vessels carrying 1000 t CO<sub>2</sub>) and so scale-up remains to be

demonstrated. Several studies have developed integrated concepts for shipping of large quantities of CO<sub>2</sub> (see, for example, Vermeulen (2011); Tetteroo and van der Ben (2011); Chiyoda Corporation (2011)). At the anticipated larger scale of operation, CO<sub>2</sub> would be transported at around 7–9 bar and –55 °C: analogous conditions to the large current fleet of liquefied petroleum gas carriers. For example, Maersk Tankers are designing CO<sub>2</sub> carriers able to transport 45,000 t of CO<sub>2</sub> per voyage based on their mid-size carriers for liquefied petroleum gas (<http://www.carboncapturejournal.com/displaynews.php?NewsID=552>).

The concept evaluation study reported by Vermeulen (2011) concludes that ship transport of CO<sub>2</sub> is technically feasible, but that a lot of improvement and optimisation of the logistics chain remains to be done. The EU CCS demonstration plants are recommended to include a ship transport option (ZEP, 2008), which would play an important role in proving the concept and allowing any operational difficulties to be resolved.

**CO<sub>2</sub> compression** can represent a significant fraction of the energy penalty for CCS, particularly for pipeline transport where transport pressures of 80–200 bar, required for supercritical operation, can result in a penalty of up to 5% on power station generating

efficiency (IEA Greenhouse Gas R&D Programme, 2007). Relatively little work has been done to optimise compression trains, but some gains may be made by appropriate combination of compression, refrigeration and pumping, although reductions in compression energy tend to be offset by increases in energy for refrigeration (Botero et al., 2009). Gas conditioning for transport will be integrated to some degree with compression, and here too there is further scope to develop optimised arrangements that will be specific to the conditions prevailing in the particular capture, transport and storage processes in which they are embedded (Aspelund and Jordal, 2007).

### 4.3 Developing Europe's CO<sub>2</sub> transport infrastructure

The European Commission's 'Energy Roadmap 2050' (European Commission, 2011f) concludes, 'CO<sub>2</sub> infrastructure, that does not currently exist, will be required and planning should be started soon.' The ZEP review of CO<sub>2</sub> transport costs (2011b) concludes that for large-scale CO<sub>2</sub> transport infrastructure, long range and central planning can lead to significantly reduced long-term costs. The IEA (2009) takes the view that, 'a significant amount of additional work is needed to map out the way in which pipeline networks and

Figure 4.1 Illustration of possible future CO<sub>2</sub> transport network: the 2050 reference scenario for CO<sub>2</sub> transport network in Europe, from Neele et al., 2010.

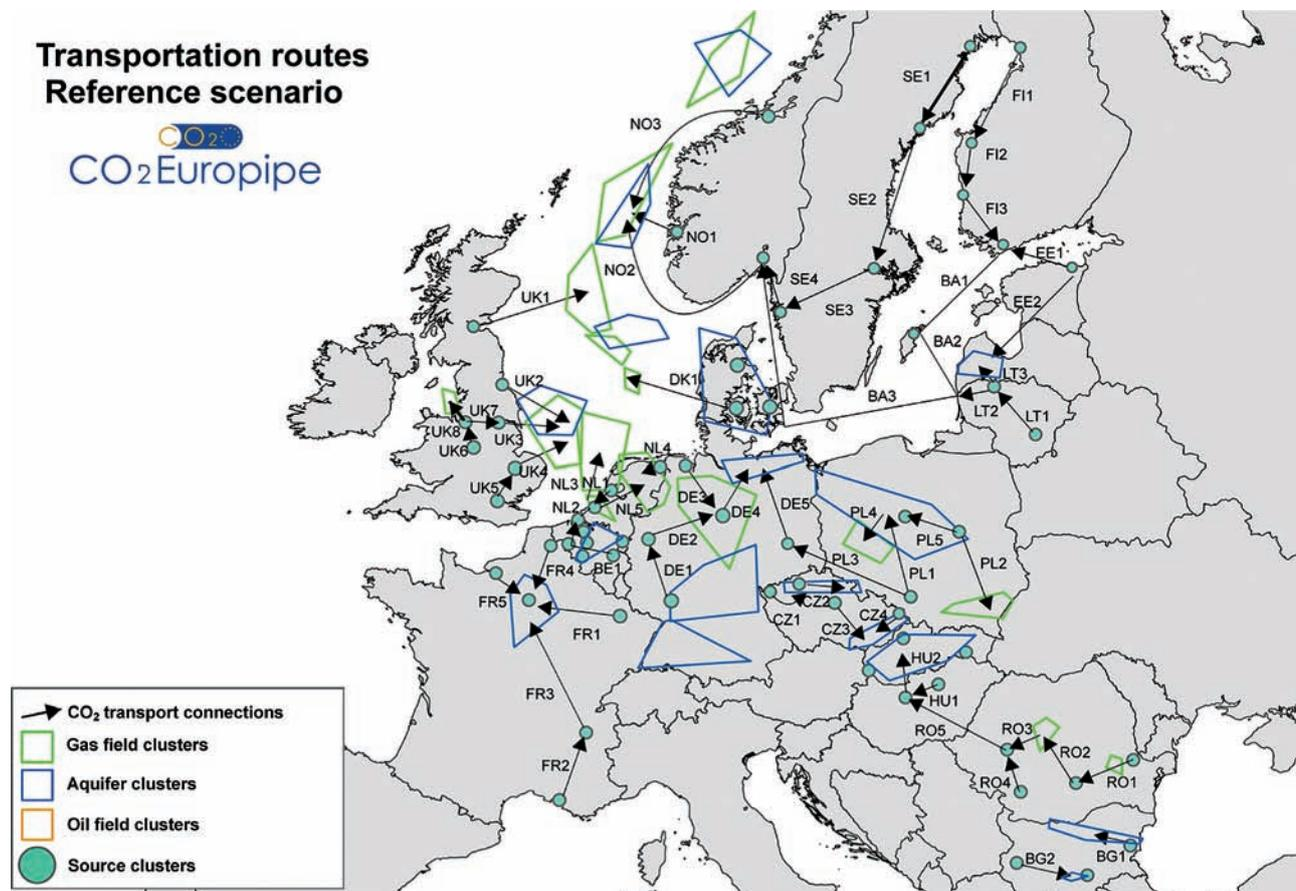

common carriage systems will evolve over time, with a long-term view that takes into account expansion from demonstration to commercialisation'. It can safely be concluded that a strategic overview needs to be developed, quickly, of the CO<sub>2</sub> transport infrastructure that will be needed to support CCS deployment in Europe to 2050.

For pipeline transport, it is anticipated to be significantly cheaper to have trunk mains gathering from a cluster of sources and distributing to a cluster of storage facilities than to have separate point-to-point connections: the Global CCS Institute (2011b) estimates the saving as 25%, the Carbon Capture and Storage Association (2011) as 40%. A trunk mains approach also has the advantage of requiring less planning permissions (a potentially important factor in enabling the required rapid development of the transport infrastructure), and it provides substantially lower costs for small capture sources. However, it brings with it the challenge of establishing CO<sub>2</sub> stream composition and operating requirements as discussed in the previous section. It is also considered unlikely to be achieved in the absence of a strategic overall CO<sub>2</sub> transport plan for Europe and key regions. Initiatives such as the CCS Regions Joint Cooperation Programme may help to raise awareness of such a strategy and may help to define region-wide transport plans.

The potential evolution of the CO<sub>2</sub> transport network in Europe to 2050 has been examined by the CO<sub>2</sub>Europipe FP7 project (Neele et al., 2010) and in the feasibility study commissioned by the European Commission's Directorate General for Energy (Ove Arup, 2010). By way of illustration of the possible extent of a future CO<sub>2</sub> transport network, Figure 4.1 reproduces the 2050 reference scenario from Neele et al. (2010), which provides for the transport of 1200 megatonnes (Mt; 1 Mt = 10<sup>6</sup> tonnes) CO<sub>2</sub> per annum through 22,000 km of pipeline, and allows both onshore and offshore storage. Although the details of this scenario in terms of the locations of sources, storage facilities and transport corridors may well prove to be inaccurate, it usefully gives a sense of the scale of development that may be required. For the reference scenario, the main part of the pipeline network is established by 2030 (with the implication that pipeline construction is most intense in the 2020s at 1200–1500 km/year), but its capacity is subsequently substantially enhanced over the period to 2050.

Ove Arup (2010) compared two approaches to designing the pipeline network – trunk mains with gathering systems, and a ring main – and concluded that although the latter would provide higher levels of security, it would cost twice as much. In 2050 in this study, 20,000 km of pipeline is needed to transport 800 Mt CO<sub>2</sub> per annum at a capital cost of €20 billion. (Globally, for the IEA 'Blue Map' scenario, 200,000

km of CO<sub>2</sub> pipelines are required by 2050 (Insight Economics, 2011). Consequently, '... transport of CO<sub>2</sub> will become an important industrial sector requiring very significant planning and investment over a relatively short period of time' (Global CCS Institute, 2011b).)

Both studies conclude the following.

- The transport challenge and cost substantially increase if only offshore storage is allowed: an additional 50% (Neele et al., 2010) or 11–33% (Ove Arup, 2010) of pipeline, costing an additional 40–65%. Ove Arup identifies the value of gaining acceptance for onshore storage as €7 billion. Neele et al. (2010) make the stronger conclusion: 'Discarding onshore storage is likely to render CCS impossible for large parts of Europe'.
- As discussed in Chapter 5, saline aquifers provide the major part of the storage capacity but their poor current characterisation constitutes a major uncertainty for planning Europe's pipeline network. Their exploration is therefore an urgent requirement.
- Although there is plenty of storage capacity for Europe as a whole, some countries do not have sufficient national storage capacity (e.g. Finland, Sweden, Estonia and the Czech Republic). Cross-border transport is therefore required, and EU level coordination is needed to develop an effective transport infrastructure.

It is expected that governments will need to play an active role in establishing the CO<sub>2</sub> transport infrastructure (Insight Economics, 2011), potentially building the pipeline network and selling it to the private sector when risks are better understood, or subsidising construction costs in a more decentralised model in which the private sector undertakes network development. A particular challenge is financing pipelines that are initially oversized in anticipation of future sources (Global CCS Institute, 2011b). There is a case for separating the ownership and operation of the transport and storage infrastructure (potentially through establishing regional owner–operators) from that of capture facilities. EU and national level funding may be needed to facilitate the development of strategic CO<sub>2</sub> transport networks, involving an appropriate balance of state and private sector funding.

Enhanced oil recovery, potentially in close-to-shore offshore fields, may offer early opportunities for CCS deployment. Combined with clusters of sources, for example as in the Humber region of the North Sea coast of the UK, such storage sites may offer early opportunities to develop local CO<sub>2</sub> transport infrastructures which can subsequently be augmented as CCS is rolled out more

broadly. As discussed in section 4.1, ship transport may play a role in providing flexibility in the initial stages, while CO<sub>2</sub> volumes necessary for economic transport in pipelines develop.

If CCS is to make a major contribution to climate change mitigation in Europe by 2050, the required CO<sub>2</sub> transport network will be on a broadly comparable scale to that established for natural gas on similar timescales. Although this provides some encouragement that the task of establishing the CO<sub>2</sub> transport network is achievable, the financial incentives to construct the natural gas network were arguably stronger, and publics have in some cases become less receptive to major infrastructure projects in the intervening period.

#### 4.4 CO<sub>2</sub> transport costs

Table 4.1, taken from the ZEP cost study (ZEP 2011a, b), reveals a wide range of projected CO<sub>2</sub> transport costs depending on the transport distance and capacity, the mode of transport and whether the storage facility is onshore or offshore. The range of around €15/t CO<sub>2</sub> in Table 4.1 (for onshore transport over 180 km to offshore transport over 1500 km) for a large-scale commercial network transporting 20 Mt/year is significant in relation to 'breakeven' costs of CCS for coal-fired power generation projected to be around €50/t CO<sub>2</sub>, as discussed in Chapter 8. For example, this range is on a par with the reduction in capture costs anticipated to be possible through technology developments over the next 20 years, as discussed in Chapter 3.

Close attention will therefore need to be given to the following.

- Optimising the overall development of CO<sub>2</sub> transport networks to enable the cost efficient connection of clusters of sources and storage facilities. As reflected in the first part of Table 4.1, the costs of point-to-point connections could be much higher, and pipeline costs become significantly cheaper per tonne transported as capacity increases. As discussed in the previous section, cost savings for Europe of 25–40% have been estimated for clustering approaches compared with point-to-point connections.
- The identification of more accessible storage capacity, minimising transport costs, to enable schemes to be economically viable in the earlier years of CCS deployment when the economics may be marginal in respect of the price of EU allowances under the ETS.
- Approaches that maximise the use of pipelines in the start-up years when they may be oversized in

relation to connected sources: for example, a linear ramp-up over 10 years can increase the average transport cost per tonne of CO<sub>2</sub> by 35–50% (ZEP, 2011b).

- Enabling the development of onshore storage, a key challenge being public acceptance.

The relative costs of ship and pipeline transport have been discussed in section 4.1. Pipeline costs are sensitive to use, as costs are dominated by sunk capital costs, whereas ship transport, at least in principle, can be deployed more flexibly to meet required CO<sub>2</sub> transport rates.

#### 4.5 Conclusions and recommendations on CO<sub>2</sub> transport for CCS in Europe

Based on additional research, development and demonstration activities on the economic and safe design and operation of CO<sub>2</sub> pipelines, as discussed in section 4.2, the necessary, high levels of confidence for large-scale deployment of CO<sub>2</sub> pipelines are anticipated to be reached in 5–10 years. For ship transport, scale-up to commercial capacities needs to be demonstrated. These research, development and demonstration activities should be progressed urgently at a European level, and through initiatives that ensure the effective dissemination of the knowledge generated.

In view of the associated economies, further initiatives should be undertaken to explore how a European CO<sub>2</sub> transport infrastructure can best be developed. An overall plan is needed for Europe, and for key regions within Europe, to enable the development of a cost effective network employing a trunk mains approach. A key area of uncertainty that needs to be addressed is to characterise better the locations and capacities of Europe's CO<sub>2</sub> storage potential, which is a necessary precursor to designing a transport network.

Another important factor impacting on the design of the network and the rate at which it can be deployed will be public acceptance issues, as discussed in Chapter 7, which may favour offshore locations for storage and place limitations on the routing of CO<sub>2</sub> pipelines. These issues need to be addressed before decisions can be made on the main corridors for CO<sub>2</sub> transport pipelines.

In respect of legislative frameworks and regulatory issues, the following need to be considered.

- The CO<sub>2</sub> transport network will sit alongside the gas pipeline and electricity transmission networks as a key component of Europe's energy infrastructure.

Initiatives to be taken in relation to the EU energy strategy to streamline permitting procedures and to improve public engagement processes for projects of European interest, as discussed in Chapter 2, are of crucial importance to CCS.

- To arrive at an optimal solution for Europe as a whole, the proposed amendment to the London Convention to enable export of CO<sub>2</sub> for storage in another country needs to be secured as discussed in Chapter 2.

- Also, revision to the CCS Directive planned for 2015 should provide more directly for ships as a CO<sub>2</sub> transport option.

In view of these considerations, and the 10-year lead times typical of similar infrastructure projects, the construction in the 2020s of a major part of the CO<sub>2</sub> transport infrastructure predicted to be needed by 2050, as anticipated in the scenarios examined by Neele (2010) and by Ove Arup (2010), seems unlikely to be achievable.

## 5 Storing CO<sub>2</sub>

This chapter discusses the issues associated with storing CO<sub>2</sub>. Storage in three types of geological setting is considered:

- mature or depleted oil and gas fields, possibly in conjunction with enhanced oil recovery;
- deep saline aquifers; and
- coal beds considered uneconomic or impractical to mine, potentially in conjunction with methane recovery.

The main part of storage capacity is estimated to be in the first two settings: storage in coal beds is anticipated to make a more limited contribution, given the availability of suitable sites and the technical challenges discussed later in the chapter.

An initial section summarises the key processes of CO<sub>2</sub> storage, and is followed by an account of the current status of CO<sub>2</sub> storage in respect of experience, cost estimates, the regulatory framework and estimates of storage potential in Europe. Section 5.3 then reviews current understanding of the processes of CO<sub>2</sub> storage and identifies the R&D activities needed to build sufficient confidence to underpin the large-scale commercial deployment of CCS.

Issues needing to be addressed in the identification and authorisation of storage sites are examined in section 5.4, which consequently reflects on the necessary characteristics of an authorisation process, and developments needed in the regulatory framework. A final section draws together conclusions and recommendations on what needs to be done to progress CO<sub>2</sub> storage in Europe.

The EU CCS Directive requires that CO<sub>2</sub> storage facilities provide 'permanent containment' and 'environmentally safe storage'. Strictly interpreted, this would require demonstration that there will be no leakage of CO<sub>2</sub> for all time—an impractical hurdle. What the Directive's requirement should mean in practice is discussed in this chapter. Various authors (for example, IPCC, 2005; Shaffer, 2010) have proposed that any leakage should not exceed very low rates. How to provide sufficient confidence to regulators and to the public that such low leakage rates will not be exceeded is a key underpinning theme of this chapter.

### 5.1 Processes of CO<sub>2</sub> storage

Geological formations in which CO<sub>2</sub> is to be stored are generally selected to have pressure and temperature conditions such that the CO<sub>2</sub> exists in so-called supercritical or, in some cases liquid, form, thus requiring a much smaller volume than in its gaseous form in the

Figure 5.1 Illustrative dependence of density of CO<sub>2</sub> on depth. Source: IPCC, 2005.

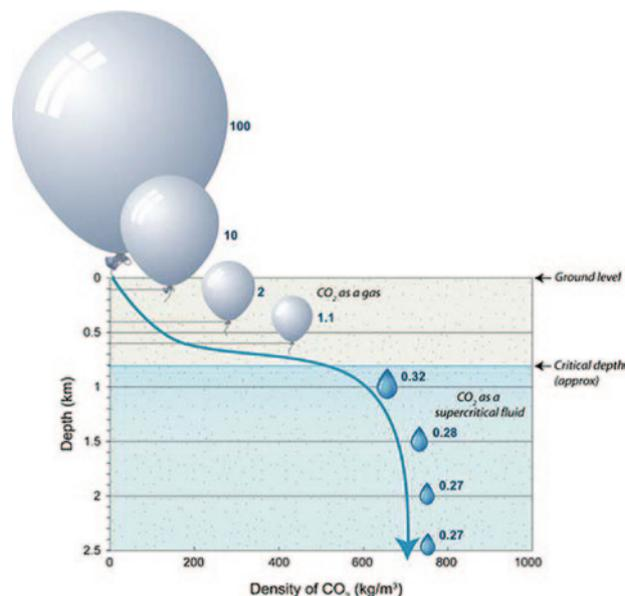

atmosphere to store a given mass of CO<sub>2</sub>. Given the relationship between the density of CO<sub>2</sub> and its pressure and temperature, this means that a depth of at least 800 m is usually needed for storage in saline aquifers and in depleted oil and gas fields (Figure 5.1 illustrates this effect for typical thermal and pressure gradients). The precise depth will depend on the temperature at the surface, the local temperature gradient and the pressure profile of the rock formation.

The mechanism for storage in coal seams is different, relying mainly on adsorption of the CO<sub>2</sub> onto the organic matter of the coal. The amount of CO<sub>2</sub> that can be held by coal depends on pressure, temperature and the petrographic characteristics of the coal (for example, coal rank, maceral composition and ash content). But increases in pressure increase adsorption, whereas increases in temperature decrease it. Moreover, the porosity and permeability of coal typically decreases with depth. This further reduces the adsorption capacity. All these elements together mean that the adsorption capacity of coal goes through an optimum that is typically located at a depth of around 1000 m (Hildenbrand et al., 2006).

Once injected into a saline aquifer or depleted oil field, the CO<sub>2</sub> will spread laterally, while simultaneously rising up, as it is lighter than the saline formation water which will be present in both types of setting. This vertical buoyancy-driven transport takes place until a low-permeability sealing layer (the cap-rock) is reached. This trapping by the low-permeability sealing layer is called **structural or stratigraphic trapping** depending on the characteristics of the rock formations. When being transported in the formation,

Figure 5.2 Evolution of trapping mechanisms over time.  
Source: IPCC, 2005.

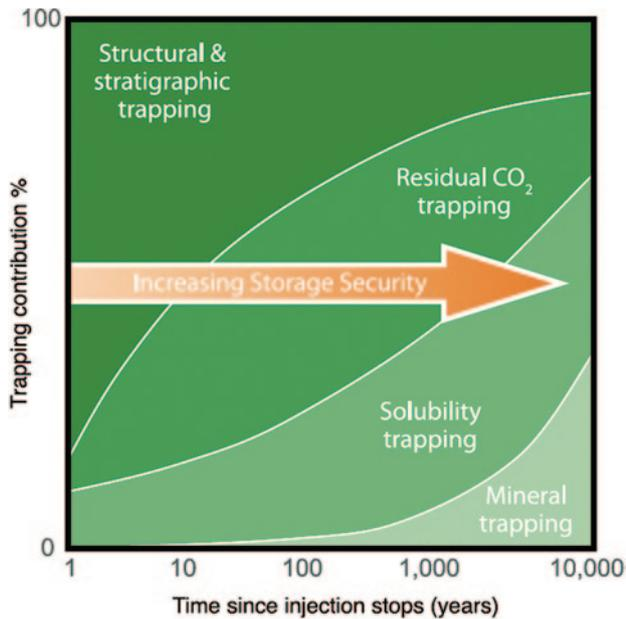

capillary forces trap a fraction of the CO<sub>2</sub> in the rock pores so that it becomes immobile. This is called **residual trapping**.

Part of the supercritical CO<sub>2</sub> will dissolve into the saline groundwater (brine) present in the formation (**dissolution trapping**). The CO<sub>2</sub> dissolution will make the brine denser, potentially causing downwards flow of the denser brine. It also acidifies the brine which can cause chemical reactions with the surrounding rock that in turn lead to dissolution of unstable minerals and, potentially, the precipitation of carbonate materials in other parts of the storage complex. As a result, part of the CO<sub>2</sub> may be incorporated into the mineral phase (**mineral trapping**). Figure 5.2 gives a conceptual depiction of the contribution of these different trapping mechanisms as a function of time, according to IPCC (2005). This is a schematic presentation and the shapes and time frames of each of the 'regions' in this trapping diagram will depend on the characteristics of the formation in question. Detailed presentations of the trapping processes are to be found in, for example, IPCC (2005), Bertier et al. (2006), Han et al. (2010), and Liu and Maroto-Valer (2011).

For a geological formation to be suitable for storing CO<sub>2</sub>, it needs to fulfil some key criteria. First, and in general terms, the porosity of the storage formation needs to be sufficiently high to provide a meaningful ratio of storage volume to rock volume for the injected CO<sub>2</sub>, and its permeability must be sufficiently large so that CO<sub>2</sub> injection can be performed with injection pressures that are not damaging either to the storage rock or the sealing layer. The rate at which CO<sub>2</sub> can be injected into the storage reservoir is called its injectivity. Second, a

low-permeability sealing layer is needed, preventing the upward migration of CO<sub>2</sub>. The integrity and continuity of this sealing layer is very important. Third, the depth and temperature of the storage formation should generally be such that the injected CO<sub>2</sub> naturally exists in a liquid or supercritical state.

Geological formations fulfilling these main criteria for saline aquifers and for mature and depleted oil and gas formations are primarily found in sedimentary basins with alternating high and low permeability layers providing suitable storage and sealing layers. Although the same differentiation between geological settings applies to both onshore and offshore underground storage, the associated hazard and risk concerns, such as leakage and induced seismicity, as well as regulatory and transport issues, vary significantly between them.

The following paragraphs summarise the main issues relevant to the performance of each of the three geological settings.

**Deep saline aquifers** provide potentially by far the largest volumetric capacity for CO<sub>2</sub> storage and are therefore of great interest when looking at CCS both in Europe and globally. Because economic motivation has, so far, been lacking, saline aquifers have generally been less investigated than mature and depleted oil and gas reservoirs, and are consequently less well characterised. The need for the native brine to be displaced by the injected CO<sub>2</sub> is greater in saline aquifers than in mature and depleted oil and gas fields, but applies to all. This may lead to pressure increases and far-field brine migration. Possible secondary effects of the large-scale pressure plume (on cap rock integrity, shallow water reservoirs, etc.) and far-field brine migration need to be properly understood, to manage CO<sub>2</sub> injection and the development of formation pressure safely.

These effects will vary depending on the characteristics of the formation. For example, the pioneering CO<sub>2</sub> injection site at Sleipner, in the Norwegian sector of the North Sea, is the largest demonstration project of CO<sub>2</sub> storage in a saline aquifer (Solomon, 2007). Since 1996, around 14 Mt of CO<sub>2</sub> have been injected into a thick, highly permeable and laterally extensive formation where pressure increases are likely not of any major concern. An extensive monitoring programme has been in place to evaluate the storage and cap rock integrity, which has confirmed that formation pressure increases have not been an issue, and has observed no significant side effects such as CO<sub>2</sub> leakage or induced seismicity. Pressure management will be more of a concern in smaller reservoir formations and reservoir formations which are divided into compartments by low permeability barriers such as faults, and/or which have low permeability.

In contrast to saline aquifers, **mature and depleted oil and gas reservoirs** will be well characterised with

several exploration and production wells. There will be far more detailed knowledge available and the production record will enable refinement of the reservoir model. Such reservoirs have also proved to be effectively sealed over geological periods. The screening and licensing phases may therefore be shorter and have lower costs than saline aquifers. However, attention has to be paid to whether there is an accurate record of existing wells that may provide leakage pathways if their positions are not known and they are not properly sealed, as well as to well integrity over the timescales required for CO<sub>2</sub> storage (particularly in respect of the quality of the cementation). Also, the pressure history of the reservoir caused by cycling of its pressure during oil and/or gas extraction needs to be evaluated for its potential to undermine the integrity of the cap rock.

There are several large, abandoned and mature oil and gas fields offshore in Europe (although their cumulative CO<sub>2</sub> storage capacity falls well short of that available in saline aquifers). Good examples are the gas fields onshore and offshore northern Germany and the Netherlands, and in southern parts of the North Sea. The amount of CO<sub>2</sub> that can be injected in depleted gas fields depends on how much gas has been produced and to what extent the field is depleted. As with most saline aquifers, extraction of formation water as CO<sub>2</sub> is injected to control pore pressure may be possible depending on the geological setting and the gas extraction strategy, and can increase storage efficiency considerably. However, potential environmental impacts need to be managed carefully, and may prove to be a limiting factor, particularly for onshore fields.

Mature oil and gas fields may still contain appreciable amounts of hydrocarbons, and for production towards the end of a field's operational life, enhanced oil and/or gas recovery with CO<sub>2</sub> (EOR/EGR) may be an important option. When injected in a mature oil reservoir, CO<sub>2</sub> dissolves into the remaining hydrocarbon phase, increasing its volume. The hydrocarbon phase consequently recovers its continuity and its viscosity decreases, which is necessary for its extraction, and it can then be remobilised by injecting water. CO<sub>2</sub> injection can produce 4–12% of the initial oil accumulation (Goodyear et al., 2002), which can represent quite a significant amount of additional reserves as, on average, the recovery factor of oil reservoirs is around 35%, and rarely exceeds 50%.

A large fraction (around 70%: US Department of Energy, 2008) of the injected CO<sub>2</sub> remains trapped in the reservoir (as, for example, at the Weyburn site in Canada), and that fraction which is produced with the oil or gas may be separated and re-injected. Several oil and gas fields in Europe have now reached a mature state where CO<sub>2</sub>-EOR/EGR is an option. As this requires both steady CO<sub>2</sub> production (i.e. CO<sub>2</sub> capture) and a supply system (i.e. pipelines), a transition to large-scale enhanced oil and gas

recovery, will reduce the costs of CCS considerably, as much of the necessary infrastructure will have been developed before the subsequent use of the field for CO<sub>2</sub> storage, and some part of the financial value of the additional oil and gas recovered can go to offsetting CCS costs. However, there are several practical problems with introducing EOR in the North Sea which could significantly increase costs and reduce yields compared, for example, to the North American experience (Stokka, 2007). Enhanced gas recovery is unlikely to give the same financial returns as EOR, but may be more applicable to onshore locations in Europe.

In **unmineable coal beds**, CO<sub>2</sub> can exist in four different states: as a free gas within pores, dissolved in water present inside the pores, as a gas adsorbed on the surface of the coal matrix, or chemically absorbed by the organic fraction of the coal. The relative importance of each of these storage mechanisms is defined by the characteristics of the coal seams and surrounding formations, as well as by the local pressure and temperature conditions. In all cases, however, the vast majority of the CO<sub>2</sub> is stored through adsorption to the internal surfaces of the coal's pores (Shi and Durucan, 2005). Most of the remaining CO<sub>2</sub> is trapped in open fractures in the coal or dissolved in the water present inside the pores.

In contrast to storage in saline aquifers and mature and depleted oil and gas fields, where large pores and consequently high porosity are favoured, storage capacity of coal beds is largely controlled by the adsorption properties of the coal and by the accessibility of the coal matrix to the injected CO<sub>2</sub> (i.e. by its permeability and the coal cleat system). Both parameters depend on the coal rank, the mineral matter content and maceral composition of the coal, as well as on CO<sub>2</sub> impurities.

A generic challenge for CO<sub>2</sub> storage in coals is that they have low permeability, making it difficult to achieve sufficiently high rates of injection. Moreover, coals tend to swell when CO<sub>2</sub> is injected, which reduces their permeability even further (Pini et al., 2009). Though high-rank coals such as anthracite are less prone to swell, they tend to have lower inherent permeability than lower-rank coals. More generally, there are systematic differences between coals depending on the environmental conditions of their genesis, which have a clear impact on the sorption capacity of coal. Although the actual process is not yet fully understood, there is ample proof that coal rank and composition control the sorption capacity of coals as they have an impact on the number of micropores (Crosdale et al., 1998; Pini et al., 2010).

As CO<sub>2</sub> is injected it will displace the methane contained in the coal bed (Mazzotti et al., 2009). Moreover, extraction of methane from the coal layers before CO<sub>2</sub> injection or injection of mixtures of CO<sub>2</sub> and other gases could help to overcome some of the problems related to the low permeability and swelling properties of coal (Pini et al., 2011).

### 5.1.1 Risk management throughout the project cycle

Experience globally of elements of CCS systems will play an important role in informing CCS developments in Europe. There are already several well-functioning CO<sub>2</sub> storage operations in place at large, medium and small scale, both in mature and depleted gas and oil reservoirs, as well as saline aquifers as illustrated in Table 5.1. In addition, there is significant experience from the related technology of enhanced oil recovery (EOR), as well as analogue systems (both natural and man-made), such as underground gas storage. In any potential storage site, it is necessary to implement a continuous, iterative process of risk assessment and reduction, covering the entire project life cycle (pre-injection, during injection and post-injection phases). The **main concerns** that need to be addressed to secure and demonstrate the safe performance of any specific site include the following:

- risks of **leakage** and their consequences in terms of environmental effects and safety;
- effects of **pressure build-up** in storage formations caused by the injection of CO<sub>2</sub>;
- the possibility of **induced seismicity**, which poses a potential nuisance, and may threaten seal integrity; and
- **long-range impacts** on other facilities and activities, including the effects of the pressure plume and far-field brine migration.

**Leakage** may be focused or diffuse. Focused leakage may occur through existing and/or abandoned wells, or through fractures and fracture zones intersecting the cap rock. In diffuse leakage, CO<sub>2</sub> migrates through the cap rock itself. Focused leakage can be monitored and detected relatively effectively by selective positioning of leakage detectors in the vicinity of the wells and fractures, as long as they are known and accessible (offshore, monitoring poses an additional layer of complexity).

To reduce the potential for leakage through the cap rock itself, or through fractures and fracture zones, requires proper site selection and cap rock characterisation, coupled to a validated model of the multiphase flow of CO<sub>2</sub>/brine systems in fractures and fracture zones from reservoir depth all the way to the land surface. Leakage may not reach the surface as the CO<sub>2</sub> may migrate horizontally through porous layers, or may be stopped by additional impermeable layers. In addition, an effective monitoring strategy is an important element of risk mitigation and public acceptance.

Contamination of potable aquifers through CO<sub>2</sub> leakage and associated mobilisation of hydrocarbons and heavy metals, is a potential risk that must be avoided. One mitigating factor is that CO<sub>2</sub> will generally be stored at much deeper levels than potable aquifers. Alternating storage and sealing layers will provide additional protection against leakage, as a leak in the first sealing layer is likely to be stopped by the second. Also, small-scale test injections have not revealed evidence of heavy-metal mobilisation.

Large-scale **pressure build-up** may become a limiting factor for storage capacity, as the over-pressurisation may cause fractures in the cap rock, may drive CO<sub>2</sub> or brine leakage through localised pathways, and may even cause induced seismicity. Well-designed injection schemes and monitoring protocols should help to mitigate the risks related to pressure build-up. The pressure increase will depend very much on the character of the boundary conditions of the reservoirs. It will be less of a problem in laterally extensive basins and basins with open or semi-open boundaries, as local pressure increases are moderated by pressure propagation and brine displacement into regions farther away. Also, diffuse as well as localised brine migration into overlying and underlying formations can enable pressure bleed-off in the vertical direction (Zhou and Birkholzer, 2011).

Ehlig-Economides and Economides (2010) considered closed systems and suggested that pressure build-up could be a critical limiting factor to storage, whereas other studies (e.g. Zhou and Birkholzer, 2011) suggest that the limiting effect will depend on these moderating factors of pressure release. Nevertheless, the effect needs to be understood, pressure increases appropriately controlled and the pressure evolution monitored. Pressure management may involve, for example, brine withdrawal (as is proposed for the Gorgon project in Australia). The pressure increases created by CO<sub>2</sub> injection should be considered in relation to other activities causing similar effects such as draw-downs from pumping related to water supply (see, for example, Zhou et al., 2008, Birkholzer et al., 2009, Zhou et al., 2010).

Human activities underground, for example to exploit natural resources, can cause pressure waves through the ground which are referred to as **induced seismicity** if they reach the surface. Typically, such events are very small, causing no damage, but can on occasion cause nuisance to local populations (National Research Council, 2012). So far, for CO<sub>2</sub> storage installations, induced seismicity has not been experienced, but relevant research on the potential for induced seismicity is currently underway.

Evans et al. (2012) have recently reviewed induced seismic response to fluid injection in geothermal and CO<sub>2</sub> reservoirs in Europe. The data generally support the view that injection in sedimentary rocks (where CO<sub>2</sub> would

be stored) tends to be less prone to induced seismicity than in crystalline rocks. None of the CO<sub>2</sub> reservoirs (e.g. Ketzin, Sleipner) has had any micro-earthquakes reported, and of the geothermal sedimentary reservoirs, only some brittle carbonate systems have reported earthquakes up to magnitude 3. Recently, Zoback and Gorelick (2012) have suggested that given the huge volumes of CO<sub>2</sub> to be stored, induced seismicity large enough to cause minor damage and, more importantly, rupture the sealing cap rock, are inevitable, but their views have been contested (see, for example, Gale, 2012).

The properties and effects of induced and natural seismicity are generally indistinguishable. Also, the Earth's crust is critically stressed in most places, so earthquakes (including large ones) can be caused in rare cases on pre-stressed faults by small changes in the pressure distribution. These observations pose challenges for operators, regulators and insurers, not least because natural earthquakes that occur in the vicinity of CO<sub>2</sub> storage sites may be attributed to their operation, and proving otherwise may be difficult. The potential for induced seismicity will need to be carefully considered as part of risk assessment, monitoring and mitigation.

The largest potential CO<sub>2</sub> storage structures in Europe have hydrodynamically open reservoirs located mainly in aseismic regions. Also, injection of CO<sub>2</sub> into permeable formations is intrinsically different to the fracturing processes in impermeable rocks associated with geothermal energy projects. Therefore, taking the seismic hazard into account should not reduce the capacity of CO<sub>2</sub> storage potential in Europe substantially. In seismically active zones, induced seismicity may constitute a risk factor that should be addressed, potentially reducing reservoir capacity.

**Long-range impacts** include the effects of the much larger zone of increased pressure in the formation water (the so-called pressure plume), as well as the effects of far field brine migration already referred to above.

Resolution of potential conflicts with other uses of the subsurface space such as oil and gas exploration, geothermal energy and gas storage, will depend on the relative values of CO<sub>2</sub> storage and other uses. Identification and avoidance, where necessary, of interferences can be achieved using accurate geological models of the underground to enable design of the CO<sub>2</sub> injection pattern to maintain the pressure of the impacted aquifers at their hydrostatic pressure level. These potential conflicts are primarily a regulatory challenge, and will require careful planning and management of underground resources, especially for onshore storage.

---

<sup>†</sup> Projects that capture, transport and store CO<sub>2</sub> at a scale of greater than 800,000 tonnes per annum for coal-based power plants, and 400,000 tonnes per annum for other sources.

## 5.2 Current status of CO<sub>2</sub> storage

The 2012 survey of large-scale integrated CCS projects<sup>†</sup> by the Global CCS Institute (2012d) identified eight operational projects and eight under construction, as listed in Table 5.1. The CO<sub>2</sub> storage is in saline aquifers for six of the 16 projects, and in mature oil and gas fields, in association with enhanced oil recovery, in the other 10. There are none in unmineable coal beds.

The 16 projects have a total CO<sub>2</sub> storage capacity of 32–37 Mt CO<sub>2</sub> per annum, but just a few of them have a monitoring, measurement and verification regime adequate to address the issue of the permanence of storage. Two projects are in Europe, both offshore in Norwegian waters and in saline aquifers: at Sleipner and Snøhvit, operating since 1996 and 2008, respectively.

Notwithstanding more recent applications in the CCS context, enhanced oil recovery using injection of CO<sub>2</sub> has been practised for around 40 years: there were 95 active CO<sub>2</sub>-EOR projects in 2007, nearly all in the USA (Moritis, 2008). Around 50 million tonnes of CO<sub>2</sub> are used annually in the USA for EOR (Parsons Brinckerhoff, 2011). This experience is relevant to CO<sub>2</sub> storage for CCS, including strategies for site characterisation, injection and well integrity guidance, reservoir simulation models, and monitoring techniques (Global CCS Institute, 2011b).

The GeoCapacity project ([www.geocapacity.eu](http://www.geocapacity.eu)) estimated the potential CO<sub>2</sub> storage capacity in Europe (Geocapacity, 2009), identifying a total of 117.0 Gt CO<sub>2</sub> storage capacity in Europe, of which 95.7 Gt is in deep saline aquifers, 20.2 Gt in depleted oil and gas fields and 1.1 Gt in unmineable coal beds. For comparison, Europe emitted 3.8 Gt of CO<sub>2</sub> in 2009, of which around half was from large point sources emitting more than 0.1 Mt CO<sub>2</sub> per annum.

Figure 5.3 from ZEP (2011c) and based on the data in the GeoCapacity study, illustrates the distribution of the estimated storage capacities for saline aquifers and depleted oil and gas fields in onshore and offshore locations. Although there are many small fields, below a capacity of around 40 Mt they are not anticipated to be economic (ZEP, 2011c). Most of the capacity is in very large fields. Capacity is roughly evenly distributed between onshore and offshore locations.

Although GeoCapacity used the guidelines of the Carbon Sequestration Leadership Forum, the estimates of effective storage capacity were based largely on theoretical assumptions, and the quality of capacity estimates and mapping across Europe was very variable. In several key countries the GeoCapacity report relied on data developed in the GESTCO project (GESTCO, 2004) over the period 1999–2003, i.e. at a rather early stage in Europe's consideration and understanding of CCS.

**Table 5.1 Large-scale integrated CCS projects that were operational or under construction in 2012 (source: Global CCS Institute, 2012d)**

Name	Country	Capture type	Volume CO <sub>2</sub> (Mt per annum)	Storage type	Date of operation
<b>Operate stage</b>					
Val Verde Gas Plants	USA	Pre-combustion (gas processing)	1.3	Enhanced oil recovery	1972
Enid Fertilizer CO <sub>2</sub> EOR Project	USA	Pre-combustion (fertiliser)	0.68	Enhanced oil recovery	1982
Shute Creek Gas Processing Facility	USA	Pre-combustion (gas processing)	7	Enhanced oil recovery	1986
Sleipner CO <sub>2</sub> Injection	Norway	Pre-combustion (gas processing)	1 (+0.2 in construction)	Deep saline formation	1996
Great Plains Synfuel Plant and Weyburn–Midale Project	USA	Pre-combustion (synfuels)	3	Enhanced oil recovery	2000
In Salah CO <sub>2</sub> Injection	Algeria	Pre-combustion (gas processing)	1	Deep saline formation	2004
Snøhvit CO <sub>2</sub> Injection	Norway	Pre-combustion (gas processing)	0.7	Deep saline formation	2008
Century Plant	USA	Pre-combustion (gas processing)	5 (+ 3.5 in construction)	Enhanced oil recovery	2010
<b>Execute stage</b>					
Air Products Steam Methane Reformer EOR Project	USA	Post-combustion (hydrogen production)	1	Enhanced oil recovery	2012
Lost Cabin Gas Plant	USA	Pre-combustion (gas processing)	1	Enhanced oil recovery	2012
Illinois Industrial CCS Project	USA	Industrial separation (ethanol)	1	Deep saline formation	2013
ACTL with Agrium CO <sub>2</sub> Stream	Canada	Pre-combustion (fertiliser)	0.59	Enhanced oil recovery	2014
Boundary Dam Integrated CCS Demonstration Project	Canada	Post-combustion (power generation)	1	Enhanced oil recovery	2014
Kemper County IGCC Project	USA	Pre-combustion (power generation)	3.5	Enhanced oil recovery	2014
Gorgon Carbon Dioxide Injection Project	Australia	Pre-combustion (gas processing)	3.4–4.1	Deep saline formation	2015
Quest	Canada	Pre-combustion (hydrogen production)	1.08	Deep saline formation	2015

For saline aquifers, which account for 80% of the total storage capacity, characterisation data and the understanding of long-term trapping mechanisms are often limited. In these cases, the capacity estimates were based on general geological models and are first regional estimates of the total reservoir volume at best. Additional exploration and an evaluation of the

actual trapping mechanisms are needed to convert these first estimates into more robust evaluations of effective storage volumes. Furthermore, the approach used in GeoCapacity did not take into account regulatory limitations, public acceptance issues, competing uses of the underground spaces and the economics of specific sites, which can have a strong

Figure 5.3 Estimated distribution of CO<sub>2</sub> storage capacity in Europe. Source: ZEP (2011c) based on data from GeoCapacity (2009).

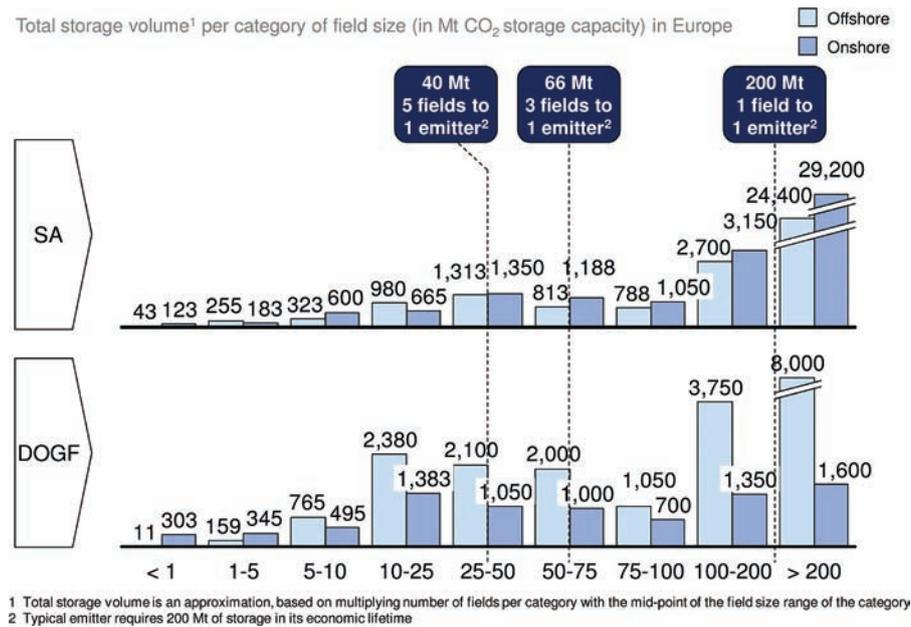

SA, saline aquifers; DOGF, depleted oil and gas fields; Offshore storage in light blue, onshore storage in dark blue.

impact on the development of certain storage sites, potentially substantially reducing estimates of storage capacity.

### 5.2.1 Storage costs

For consistency with cost information presented in the Chapters 3 and 4, and in the summary of cost information presented in Chapter 8, cost information on storage has been extracted from ZEP cost reports (2011a, c). Estimated cost data are presented for depleted oil and gas fields and saline aquifers for both onshore and offshore settings. For depleted oil and gas fields the possibility of re-using legacy wells was also examined in the ZEP study.

With reference to Figure 5.4, for each of the six main options considered, ranges of costs are presented derived by setting key parameter values (for field capacity, well injection rate and liability transfer costs) to low, medium and high values. A wide range of costs per tonne of CO<sub>2</sub> stored results (€1–20/t; see Figure 5.4), arising primarily from the variation in the key, cost-sensitive characteristics of the storage reservoirs considered. Unsurprisingly, onshore storage is cheaper than offshore, and disused oil and gas fields are cheaper than saline aquifers.

Most of the anticipated storage capacity is in the more expensive settings: saline aquifers and/or offshore depleted oil and gas fields. Rather little is available in onshore depleted oil and gas fields. Figure 5.5 summarises the cost sensitivities examined in the ZEP study, and points to the importance of field capacity and well injection rate.

The sensitivity analysis shows substantially higher upside costs than downside. Moreover, the current status of CCS projects in Europe shows that proposals for storage sites are increasingly shifting to offshore sites, which are in the higher cost range, owing to public acceptance and regulatory issues.

The variations in cost are significant in relation to the projected 'breakeven' costs of CCS of around €50/t CO<sub>2</sub> for coal-fired power stations as discussed in Chapter 8, and could determine whether or not CCS is economic in the early decades of CCS deployment. High-capacity fields with good injectivity, lying at the lower ends of the cost ranges, are at a premium: an early priority for progressing CCS in Europe is to undertake the necessary field characterisation work to enhance confidence in their location, capacity and injectivity. Such characterisation will represent a substantial up-front investment, which is not entirely included in the cost estimation by ZEP. Similarly, public acceptance of onshore storage will be an important factor in influencing the economics of CCS, pointing to the importance of public engagement initiatives across Europe.

### 5.2.2 The regulatory framework for storage

For the EU, the overall regulatory framework for storage of CO<sub>2</sub> is set out in the CCS Directive (European Commission, 2009a), which includes at Annex 1 generic criteria for the characterisation and assessment of a potential storage site. The stated purpose of geological storage of CO<sub>2</sub> is that it should be permanent and environmentally safe, and should prevent, or eliminate

Figure 5.4 Estimated storage costs with uncertainty ranges. Purple dots correspond to base assumptions. The orange and black dots correspond to the low- and high-range estimates. Source: ZEP, 2011a.

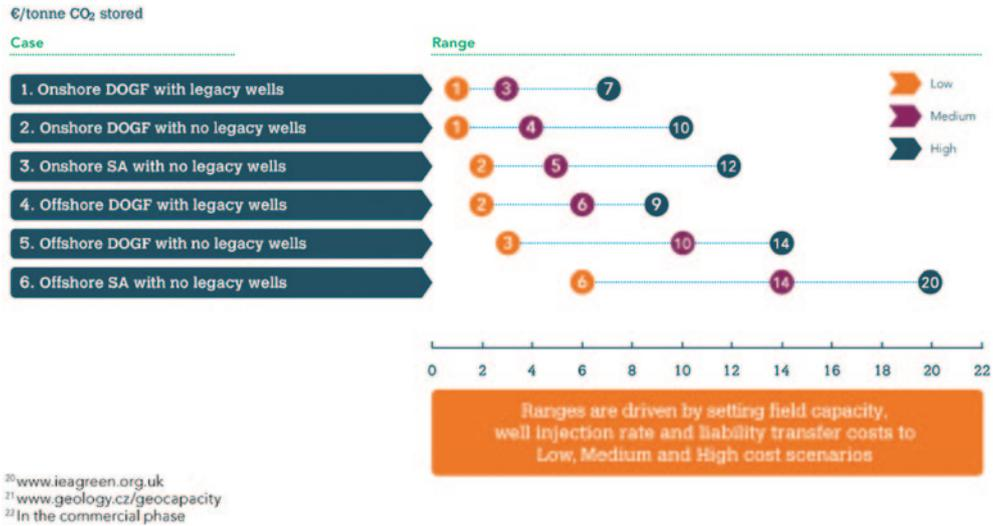

<sup>20</sup> www.ieagreen.org.uk  
<sup>21</sup> www.geology.cz/geocapacity  
<sup>22</sup> In the commercial phase

Figure 5.5 Illustration of sensitivities in the storage cost estimates. Source: ZEP, 2011a.

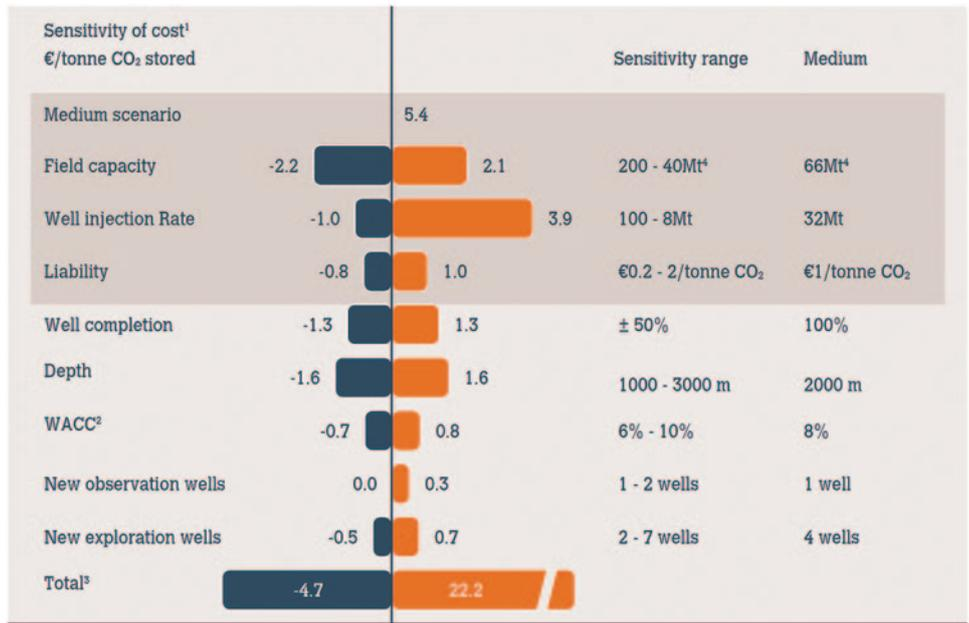

<sup>1</sup> The sensitivity denotes the individual effect of ranging a parameter on the total cost in Medium scenario  
<sup>2</sup> Weighted Average Cost of Capital  
<sup>3</sup> Parts do not add to total. Combined effect of variables is larger due to independencies  
<sup>4</sup> High scenario is 1 emitter to 1 field; Medium scenario is 1 emitter to 3 fields; Low scenario is 1 emitter to 5 fields

as far as possible, any negative effects and risk to the environment and human health. Annex 1 of the Directive specifies that the site characterisation and impact assessment need to be carried out in three steps: (1) data collection; (2) building a three dimensional static model of the geology; and (3) characterisation of the storage dynamic behaviour, sensitivity characterisation, and risk assessment.

A review of the Directive will be submitted to the European Parliament and Council by March 2015, which will include the further development and updating of the criteria set out in Annex 1 in light of experience with

CCS and the implementation of the Directive, and taking into account technical progress and the most recent scientific knowledge. It is noted that on this timescale, no experience of CO<sub>2</sub> storage will be available from the proposed European demonstration plants (see e.g. <http://ec.europa.eu/energy>).

The provisions of the Directive have to be transposed into the legislative frameworks of EU Member States as discussed in Chapter 2. This transposition includes the establishment of appropriate national regulatory frameworks for CCS and, in particular, for the storage of CO<sub>2</sub>. These may impose stricter rules

than those set out in the Directive when it comes to safeguarding the environment and human health, but must be fully harmonised in respect of the functioning of the internal market. To ensure consistency in implementation of the requirements of the Directive, all storage applications for the early CCS projects are required to be made available to the Commission for evaluation.

A set of four guideline documents for the implementation of the Directive was published by the Commission in 2011 (European Commission, 2011a, c–e). They set out the Commission's view on how the storage site operator and the competent authority (the 'regulator') should interact over the lifecycle of the storage facility, which is divided into six main phases (assessment, characterisation, development, operation, post-closure/pre-transfer and post-transfer), separated by five major project or regulatory milestones (award of exploration permit, award of storage permit, start injection, cease injection/closure and transfer responsibility to Member State). A risk management approach (iterative identification and ranking of risks, and implementation of management measures) is recommended as a central element of the approach to managing the storage project, and as the basis of the interaction between the operator and the competent authority.

### 5.3 Understanding of CO<sub>2</sub> storage processes: current position and development needs

#### 5.3.1 Current position

Our current knowledge and understanding of CO<sub>2</sub> storage processes stem from several ongoing geological storage and research projects, experiences from the petroleum industry (including enhanced recovery utilising CO<sub>2</sub>), underground gas and liquid storage facilities, and not least from natural underground reservoirs of CO<sub>2</sub> that are millions of years old, so-called natural analogues. In addition, the past decade has seen an exponential growth in experimental and theoretical research dedicated to increasing our understanding of the main processes. CO<sub>2</sub> storage in the Sleipner, In Salah and Snøhvit facilities, and an increasing number of field-based research projects, are important reference cases for modelling studies to predict long-term geological storage of CO<sub>2</sub>.

Evaluation of the long-term performance of a storage site is required by the CCS Directive (European Commission, 2009a), and will be a critical factor in obtaining public acceptance. Key questions that this evaluation of the long-term performance will need to address will include the following:

- How well (and with what degree of confidence) are we able to demonstrate that the injected CO<sub>2</sub> will stay within the designated storage site?

- Do we have monitoring techniques sufficiently sensitive to detect significant leakage (significance being determined by the specifics of the safety case of the storage facility) or other possible undesired effects such as on-set of unacceptable levels of induced seismicity?
- Can minor leakages out of the reservoir, for example to the surface or to potable aquifers, be allowed?
- Are there alternative reservoir formations in case of a need for remediation?
- What are the effective boundaries of the storage complex, reflecting its zone of influence on the underground environment?

The long-term fate of CO<sub>2</sub> stored in the subsurface will depend on several factors. In mature and depleted oil and gas reservoirs, it is expected that liquid or supercritical CO<sub>2</sub> will, for the most part, be trapped structurally as a separate phase. Residual trapping by capillary action in the rock pores will occur during CO<sub>2</sub> injection, and subsequently, if the CO<sub>2</sub> plume continues to move. There is the potential for accompanying dissolution of CO<sub>2</sub> in the brine and convective mixing, but we need to improve further our ability to predict this effect to be able to take full credit for this retention process in a safety case for a storage facility.

Geochemical reactions will cause dissolution of several reservoir minerals, and subsequent precipitation of carbonates and clay minerals, potentially increasing both the dissolved fraction of CO<sub>2</sub> and the amount of mineral trapping (Wigley et al., 2012). Geochemical simulations (Pham et al., 2009) have shown that the more rapid mineral reactions take place over tens to hundreds of years, while others continue for thousands of years. The extent and timing of these reactions are uncertain, but the amount of solution and mineral trapping will tend to increase with time, leading to reduction in CO<sub>2</sub> fluid pressure.

In large saline aquifers with groundwater flow, the residually trapped fraction is expected to increase over time, and the same will be the case for solution and mineral trapping, owing to larger contact area between CO<sub>2</sub> and brine. In large, gently dipping aquifers ('migration assisted storage'), an even larger fraction will be subject to residual trapping, followed by solution/mineral trapping, thus over time, decreasing the risk of leakage.

The long-term solution and mineral trapping of CO<sub>2</sub> have large uncertainties at present, most notably so far because of limited field evidence, but also because of lack of kinetic data on mineral dissolution/precipitation, as well as other reservoir data needed for constraining geochemical model

predictions. Additional uncertainties relate to the geochemical interaction with seal materials. In the 100–1000 years' perspective, reactive diffusion of dissolved CO<sub>2</sub> into the cap-rock may be important. As for geomechanical considerations, the injection/filling phase of CO<sub>2</sub> into the geological storage site needs to be managed carefully by the operator, as demonstrated both in the Snøhvit case, and in several other drilling/injection operations (Eiken et al., 2011). In the long-term, geochemical interactions with both the reservoir and seals (cap-rock and well cement) may change their geomechanical and geophysical properties. At present, these effects are not fully understood, and are consequently difficult to quantify and predict.

Storage of large volumes of CO<sub>2</sub> implies associated brine displacements and large-scale pressure plumes. As discussed in section 5.1, large-scale pressure build-up may cause fractures in the cap rock, may drive CO<sub>2</sub> or brine leakage through localised pathways, and in some regions may cause induced seismicity. The likelihood and significance of these effects will depend on the properties of the storage medium and the state of its boundaries. Although the overall character of the governing processes is believed in general to be relatively well understood, work is needed to understand and be able to predict the magnitude and significance of these processes at various conditions. This will involve rigorous modelling and model validation through different types of measurement from the laboratory scale to the field scale. Based on such results, monitoring programmes need to be developed that allow early detection of possible negative effects.

In the regions where higher levels of natural seismicity coincide with hydrodynamically closed reservoirs (which applies in only a rather limited number of potential storage sites in Europe), induced seismicity poses several potential challenges to CO<sub>2</sub> storage:

- nuisance to local populations, and risk of non-structural and structural damage to buildings and infrastructure;
- leakage through faults that cross the cap rock and have been created or activated as a consequence of the reservoir pressurisation;
- distinguishing between induced and natural earthquakes; and
- public acceptance.

Research is underway to address all of these issues, which requires an interdisciplinary approach involving geophysicists, geologists, engineers and social scientists. This research should lead to commonly accepted standards to assess and mitigate the potential risks posed

by induced seismicity, including for example advanced traffic-light systems that connect observations of induced seismicity with predictive reservoir models to assess future seismic risk.

Displacement of the brine, potentially through sealing layers or through the outer boundaries of the storage formation, may cause water quality changes in adjacent aquifers. The Frio experiments (Kharaka et al., 2006), where CO<sub>2</sub> was injected down-dip in one well and the formation brine was sampled in a close neighbouring well, showed that CO<sub>2</sub> saturated brine could mobilise heavy metals and organic compounds into overlying aquifers.

Geophysical monitoring (seismic, gravimetric and electromagnetic methods) can to a certain extent detect changes in gravity, sound velocity, resistivity and other electromagnetic properties, caused by fluid substitution during CO<sub>2</sub> injection. It is important to recognise that such monitoring will always have a considerable uncertainty in calculating the mass of CO<sub>2</sub> stored (Nooner et al., 2007). This is inherent in all the methods themselves. In addition, all indirect geophysical techniques are only relevant for separate phase CO<sub>2</sub>, and are not able to detect the fraction dissolved in pore water or precipitated as solid minerals.

Present-day modelling tools, derived in large part from the petroleum industry, are able in a coarse way to simulate the overall reservoir-scale two-phase flow behaviour, giving estimates of the amount of separate phase CO<sub>2</sub> trapped structurally or stratigraphically, and the residual trapping. However, even the best reservoir model represents an upscaling where the spatial geological heterogeneity found in porosity and permeability variation, fracture network, etc. cannot be fully represented. Therefore, well-founded upscaling methodologies and rationales for use of models of various levels of accuracy at different scales are needed. A good characterisation of the storage complex is an important part of this process. There is also a need for improvement of the ability of dynamic models to handle the physical and chemical processes involved in solubility and mineral trapping.

The geomechanical response to underground CO<sub>2</sub> injection must also be included in the simulators. The experience from In Salah and Snøhvit has clearly demonstrated this. In Salah experienced a surface heave of 5–7 mm/year owing to a combined response from its reservoir and overburden deformation (Vasco et al., 2008; Onuma and Ohkawa, 2009; Rutquist et al., 2010). Furthermore, microseismicity data combined with the injection history clearly indicated that formation fracturing had taken place (Oye et al., 2012). At the Snøhvit storage site, the reservoir selected initially had to be abandoned owing to high-pressure build up and decrease in injectivity, so another reservoir unit has subsequently been used (Eiken et al., 2012).

Fault reactivation as a consequence of fluid pressure build up is yet another geomechanical aspect to consider. The geochemical reactivity of separate phase and dissolved CO<sub>2</sub> with both reservoir and cap-rocks, and well cement has been of concern for potential detrimental effects, but with no conclusive evidence so far to determine with confidence whether or not such effects could be significant for the long-term integrity of storage facilities. It is considered that the scientific community has a fair understanding of the key processes as separate topics, but the coupling of processes needs more attention.

### 5.3.2 Key areas of uncertainty

Although CO<sub>2</sub> storage for CCS projects can draw on the breadth of knowledge and experience outlined above, significant uncertainties still remain about CO<sub>2</sub> storage processes and the behaviour of storage facilities during operation and over the long term, many of which have been discussed in the preceding section. It should be recognised that there are differences of opinion within the scientific community about the significance of some of these uncertainties for the evaluation and authorisation of CO<sub>2</sub> storage facilities. The views presented here reflect the expert judgement of the EASAC Working Group members.

Two key issues for a CO<sub>2</sub> storage facility are its **capacity** (the amount of CO<sub>2</sub> that it can store) and its **integrity** (demonstrating that CO<sub>2</sub> is stored in a safe and permanent way in the sense intended by the CCS Directive).

To estimate the **capacity** of a potential site to host CO<sub>2</sub> storage better, an improved understanding is needed of the heterogeneity of the sediments of reservoirs and how host-rock composition (its mineralogy and organic matter content), grain size distribution (particularly in respect of CO<sub>2</sub> wetting behaviour), depositional facies changes and hydrological properties determine storage efficiency. Injectivity, the rate at which CO<sub>2</sub> can be injected into a formation, strongly influences the economics of storage, and depends on how the pressure in the formation responds to the rate of injection and evolves afterwards. This pressure dependence, and its relation to the characteristics of the host geology, is a key area of uncertainty.

To evaluate the storage capacity of regional saline aquifers, methods are needed to establish the horizontal connectivity of formations that could store CO<sub>2</sub> and the extent of overlying formations capable of acting as effective cap rocks.

To reduce uncertainties in capacity estimates and mapping, standardised storage assessment criteria need to be established (analogous to mineral resource definition), and the data generated to enable the development of an integrated European Geological

Storage Atlas. Such an initiative needs to be adequately funded. The European Commission should take a key responsibility for developing a sufficiently detailed understanding of storage capacity across Europe. This is particularly so in some storage locations, like the Baltic and North Seas, which are of interest to several countries for storage, and so are appropriately addressed at the EU level. A practical solution may be for individual countries to map their storage capacity using criteria and categories established at a European level, followed by the integration of information by the Commission.

With regard to a site's **integrity** over the necessary long periods, a generic challenge is how to identify potential escape pathways for CO<sub>2</sub>, particularly because of inhomogeneities in the sealing rock and the presence of faults and fault zones that also could be activated by induced seismicity. Better multi-phase flow models are needed to predict CO<sub>2</sub> flow through potential leakage pathways, and techniques need to be developed to enable the detection and appraisal with sufficient resolution of soft-sediment intrusions which can act as channels in what may otherwise appear to be a homogenous cap seal lithology. Similarly, good methods are needed to identify and detect fractures and fracture zones in the cap-rock as well as to identify and appraise abandoned wells, a particular issue for the use both of onshore and offshore depleted oil and gas fields that may have been penetrated by several hundred wells during their operational lifetime.

Injected CO<sub>2</sub> interacts with, and may alter, the host rock. A better understanding is needed of the mechanical and chemical impacts of injection on cap rock integrity, and of the potential to induce seismicity. For faults, which might act as escape pathways, the factors in different host lithologies that will determine whether CO<sub>2</sub> injection may reactivate them need to be better understood. Alternatively, the CO<sub>2</sub> may react with fault gouge material, enhancing mineralisation and blocking or constricting possible leakage pathways, but such effects are not well understood.

More knowledge is also needed of the relationship between the physical and chemical properties of the CO<sub>2</sub> stream during injection and in the storage facility, and its composition as determined by impurities carried over from the capture process.

### 5.3.3 Recommendations for R&D priorities

The areas identified above, where improved understanding is needed, lead to the identification of R&D priorities. In identifying such priorities, it is appropriate to observe that research so far has not identified any insurmountable obstacles to our eventual ability to adequately characterise and predict the behaviour of CO<sub>2</sub> storage sites.

The European demonstration projects will provide important platforms for R&D at scales closely related to commercial facilities: a general priority will be the calibration and validation of models of the behaviour of the injected CO<sub>2</sub> in the associated storage facilities. However, smaller-scale field experiments will also make an important contribution by identifying and characterising many of the key processes (such as the main trapping mechanisms) in *in situ* conditions and in well-controlled environments. Laboratory experiments on very large samples can also increase understanding of carbon trapping processes and help to calibrate model parameters. There is a case to increase the number of pilot injection test sites (similar to that at Ketzin in Germany ([www.co2ketzin.de](http://www.co2ketzin.de)) and Lacq in France (Total, 2007)) across Europe, to perhaps five or six in total.

- To improve capability of estimating storage **capacity**, key R&D priorities include the following:
  - development of models of brine displacement due to CO<sub>2</sub> injection, and their validation and calibration through pilot tests;
  - evaluation of hydrodynamic effects of pressure increase during industrial-scale CO<sub>2</sub> injection;
  - improved tools to forecast the seismic response and potential for fault re-activation of a reservoir during initial screening;
  - associated with the previous point, appraisal of the relative benefits of 'migration assisted storage' in complex, large aquifers and storage in more limited, structurally closed, reservoirs;
  - development of improved understanding of the mechanisms of residual and dissolution trapping in *in situ* conditions, and the role of geological heterogeneity in them;
  - development of improved approaches to take into account formation heterogeneity;
  - investigation of the role of different injection strategies in enhancing trapping while reducing possible adverse effects of undesired pressure increase; and
  - to facilitate all of the above, dedicated field injection experiments with associated sampling and monitoring are a necessity for our confidence in process understanding and for model validation.

R&D is also needed to maximise the amount of CO<sub>2</sub> that can be stored in a storage facility, including evaluation of injection strategies to maximise the flow of CO<sub>2</sub> through a larger part of the reservoir (the sweep efficiency) and

to reduce pressure increase through simultaneous water production.

R&D priorities in respect of a site's **integrity** follow directly from key uncertainties discussed above:

- development of methodologies to determine basin-wide cap rock integrity, a key issue for industrial-scale injection, in particular to establish the geometry and continuity of seal complexes and any lateral variations in sealing properties, and to understand the geomechanical responses of cap rocks;
- improving understanding of the factors which determine the sealing properties of pre-existing faults and fractures in cap rock, including geomechanical response to pore pressure increase due to CO<sub>2</sub> injection, and CO<sub>2</sub> reactivity with fault rocks and vein materials;
- development and validation of techniques to assess and monitor the risk posed by ground shaking and cap rock failure due to faulting;
- observation of the long-range pressure footprint in large-scale injection experiments, its impact on the hydrodynamic equilibrium between brine and freshwater, and the long-term impact on seismicity; and
- development of improved methods to evaluate the sealing performance over long periods of abandoned wells.

Related to the issue of site integrity is the evaluation of the environmental and safety impacts of potential leaks. Here, prediction of the worst case of rapid CO<sub>2</sub> release and its consequences at the surface, and modelling of CO<sub>2</sub> leakage and its consequences for freshwater reservoirs, are considered to be R&D priorities.

More generally, continuous development of improved techniques and strategies is needed for **site characterisation** before injection as well as **monitoring** to establish what is actually happening underground. Further developments are needed in validated **models** of storage processes to capture understanding and which can be used with confidence to predict the future performance of the storage facility.

An important function of **monitoring** is to track the migration of the CO<sub>2</sub> plume: related R&D challenges include the development of passive seismic survey methods and optimising networks of fluid sampling points to detect and monitor potential leakage pathways. Linked to this is the development of monitoring techniques capable of determining the mass of stored CO<sub>2</sub> with sufficient accuracy for regulatory purposes (more generally, consistency is needed

between regulatory requirements and what monitoring technologies can deliver). Techniques are also needed for early detection of strains and stresses that could induce seismicity. For all of these monitoring needs, R&D on satellite imaging may enable it to play an important role for onshore storage facilities. Early test injections are needed to enable the testing of monitoring techniques.

In addition to monitoring, techniques should be developed and tested that allow mitigation of CO<sub>2</sub> leakage and unanticipated expulsion of saline brines from the storage formation, which could harm surrounding environments.

Long-term storage performance needs to be predicted by **models**, which places high requirements on their reliability, and consequently their validation. When modelling the progress of storage, a well-tested procedure is to use a 'blind prediction approach' where model predictions are made in advance of monitoring and then compared with the monitoring results. A key issue here is to decide what differences between observations and predictions are consistent with the model being considered to be 'successful', and hence validated. Field-scale experiments in different types of setting and conditions will be necessary and will play a crucial role in model validation and refinement.

To gain confidence in long-term performance predictions, an approach successfully used in connection with radioactive waste disposal has been international model cross-comparison initiatives in which formal procedures are used to compare model predictions of laboratory experiments, field experiments and finally long-term effects. Confidence in a model's predictions is increased if truly independent modelling approaches give similar results. If the predictions differ, the reasons need to be investigated and understood.

Specific model developments that are needed include the following:

- refinement of coupled thermal-hydrological-mechanical modelling of CO<sub>2</sub> storage;
- chemo-mechanical interaction between CO<sub>2</sub>, formation fluids and host rock; and
- integration of regional flow of formation fluids in multiphase and multi-component models of CO<sub>2</sub> injection.

As emphasised at the start of this section, large-scale injection experiments are a priority. The monitoring programmes connected with the proposed demonstration projects should be extended so that as much as possible can be learned from these expensive initiatives, and arrangements should be put in place to maximise the shared learning from these publicly funded projects. EU funding should be appropriately

structured so that it provides a mechanism to ensure that the required research is undertaken and disseminated. It should focus on the experimentation integrated with these demonstration projects, in particular on issues associated with industrial-scale injection and building public confidence, such as examining the chances and consequences of leakage.

#### 5.4 Reflections on the authorisation of CO<sub>2</sub> storage sites

The CCS Directive and subsequent implementation guidelines (European Commission, 2009a, 2011a, c–e) appropriately take a risk management approach to authorisation of CO<sub>2</sub> storage sites in which confidence is built iteratively through an interaction between the site operator and the regulator. In general, the EASAC Working Group consider that the guidelines are appropriate and helpful.

'Permanent' and 'environmentally safe' are terms used in the Directive, but not adequately defined. The viability of CO<sub>2</sub> storage depends on their definitions, as it must be possible scientifically and economically to deliver the site characterisation and understanding necessary to meet the definitions. Also, they are of keen interest to the public, whose support for CCS will depend on whether they consider them appropriate. Further deliberation is needed with the scientific community, and CCS stakeholders more generally, to arrive at a definition that is practical in scientific and economic terms, and provides sufficient reassurance of safety to the public. The possibility of some, safe, level of leakage of CO<sub>2</sub> over time needs to be allowed: what constitutes 'safe' needs to be addressed by the regulatory process on a case-by-case basis, paying particular attention to potential impacts on potable water, and the global context of climate change mitigation and adaptation strategies.

The following observations on the authorisation process are made with a view to the planned revision of the Directive, in particular its Annex 1, in 2015 and the recognised need to refine the guidelines progressively as knowledge and experience are acquired.

1. Building public support for CCS will be essential if it is to make a significant contribution to climate change mitigation in Europe. As discussed in Chapter 7, CO<sub>2</sub> storage is generally the crux of public concerns and the key to gaining their acceptance. The authorisation process therefore needs to integrate public engagement appropriately, ensuring that public concerns and framings of the issues are addressed in the data and modelling required from the operator and the way it is presented.
2. More emphasis should be put on developing approaches to building sufficient confidence in

the performance and safety of storage in the long term (hundreds and thousands of years). That long-term view becomes more important as the cumulative legacy of stored CO<sub>2</sub> increases. It is not apparent that such a long-term mind set is yet sufficiently embedded in the guidelines. Some examples are as follows:

- consideration of the 'local population density' at risk from CO<sub>2</sub> leakage needs to have regard to shifting centres of population over hundreds of years;
- industry good practice on borehole sealing will be only of limited value in ensuring integrity over timescales of 100+ years; and
- inadvertent intrusion, particularly into depleted oil and gas fields, in several centuries when priorities may have changed and/or records may well have been lost is an important issue to consider.

Such effects cannot, of course, be definitively predicted far into the future, but a systems analysis of features, events and processes that are relevant to the behaviour of stored CO<sub>2</sub> over time can enable a transparent and systematic evaluation of future scenarios, and should be effectively integrated into risk assessments to inform regulatory decision making (Stenhouse et al., 2006; Lewicki et al., 2007). Such methodologies have been adapted for evaluating CO<sub>2</sub> storage facilities from methods developed in connection with radioactive waste disposal (see, for example, Savage et al., 2004; Toth, 2011; and the database of features, events and processes for evaluating CO<sub>2</sub> storage in IEAGHG 2012).

3. Confidence that storage will be permanent and secure, according to a practicable definition of these terms as discussed earlier in this section, needs to be high before authorisation is given to start injection: the storage process is not easily reversible if it subsequently transpires that the site is not suitable because, for example, of concerns about CO<sub>2</sub> leakage. In that scenario a 'real time' problem arises given that the capture facility will continue to generate CO<sub>2</sub> for storage. The requirement in the guidelines for 'corrective measures' needs to ensure that there is a 'plan B' for that CO<sub>2</sub>. More broadly, potential problems need to be systematically identified and evaluated, and contingency measures established to deal with them, as is routine practice for industrial plants in general. So far, little attention has been paid to this 'plan B', nor to the development of techniques that allow mitigation and curing of leakage of CO<sub>2</sub> or adverse effects due to the expulsion of saline brines from the storage site.

4. It is recognised that the initial stage of site characterisation will take several years (up to 11 in the guidelines), particularly for saline aquifers and in light of the considerations outlined in the previous point. Subsequent knowledge accumulation and confidence building during the injection phase will similarly be measured in decades, not just years, although every effort should be made to design predictive exercises and monitoring to accelerate progress up the confidence curve. The demonstration plants should be designed to provide early answers wherever possible to key issues of storage, even though they will continue over 10–20 years to develop the knowledge and understanding necessary to underpin confidently the commercial roll-out of CCS. These timescales have an important bearing on the rate at which CCS may be deployed in Europe: the major investments required for capture plants and transport facilities are unlikely to be made in the absence of secured CO<sub>2</sub> storage facilities.
5. Understanding of the processes determining the long-term behaviour of a storage facility may appropriately be derived from analogues such as the storage of oil and gas in formations over millions of years. However, such understanding may be difficult to assimilate in quantitative risk assessments. The confidence building and regulatory process therefore needs to take a sufficiently broad view of the evidence so that a well-informed decision can be made.
6. Specific issues needing to be addressed by the regulatory framework include the following:
  - how terms should be set in the storage permit to govern CO<sub>2</sub> plume migration in relation to the concession area/boundary;
  - the long-range pressure impact of industrial-scale injection;
  - governance of potential conflicts between different types of subsurface use (oil, gas, geothermal energy, etc.) and CO<sub>2</sub> storage needs: complex management supported by numerical modelling;
  - transfer of responsibility schemes for different storage arrangements; and
  - the definition of geological unsuitability in relation to derogation from transposition of the Directive on grounds of unsuitable geological resources.
7. Adequate storage sites are unevenly distributed across Europe. Access to CO<sub>2</sub> transport networks and storage sites, irrespective of the geographical location of potential users within the EU, therefore

could become a condition for entry into, or competitive operation within, the internal electricity and heat market, depending on the relative prices of carbon and CCS. It is therefore appropriate to make arrangements for potential users to obtain such access. This should be done in a manner to be determined by each Member State, applying the objectives of fair, open and non-discriminatory access and taking into account, *inter alia*, the transport and storage capacity that is available, or can reasonably be made available, as well as the proportion of its CO<sub>2</sub> reduction obligations pursuant to international legal instruments and to European Community legislation intended to be met through CCS. Pipelines for CO<sub>2</sub> transport should, where possible, be designed to facilitate access to CO<sub>2</sub> streams, meeting reasonable minimum composition thresholds. Member States should also establish mechanisms to enable expeditious settlement of disputes about access to transport networks and storage sites.

## 5.5 Conclusions and recommendations on storage

The key chemical and physical processes that retain CO<sub>2</sub> in a storage facility depend on the geological setting and will evolve over time. The processes are broadly understood, but significant uncertainties remain which will need to be addressed to provide sufficient confidence to regulators and the public that CO<sub>2</sub> storage will be safe over the long term. Pilot and demonstration plants will play a key role in developing this confidence. Consequent recommendations for R&D priorities have been identified in section 5.3 for storage capacity, site integrity, monitoring, and model development and validation.

The precise levels of confidence that will eventually be required for the various issues impacting on the long-term safety of CO<sub>2</sub> storage, and the consequent degree of resolution of these uncertainties that will be expected, will emerge from an iterative process of confidence building between developers and regulators, in which publics should play an active part. Acceptable levels of confidence and resolution of uncertainties will be influenced by the urgency of action to mitigate climate change on the one hand, and by liability issues, public concerns and the long periods over which CO<sub>2</sub> must be safely stored on the other.

The rate at which uncertainties can be resolved, and knowledge gained, will be constrained by the need to observe geological processes, some over periods of years to build sufficient understanding, but others (for example CO<sub>2</sub> migration and retention processes, and borehole seal integrity) potentially over decades. Similarly, characterisation of a candidate storage site to achieve sufficient confidence to commit to CO<sub>2</sub> injection may take up to 10 years, particularly for saline aquifers (see Annex 3). These factors will be an important influence

on the rate at which CCS can be deployed in Europe. Research, development and demonstration activities consequently need to be progressed without any unnecessary delays.

Commercial and demonstration CCS plants are coming into operation worldwide, and more are planned. Provided they are appropriately set up to generate, understand and disseminate the information arising from such large-scale CO<sub>2</sub> injection activities, they will be an important driver of improved understanding of CO<sub>2</sub> storage processes. In Europe, the planned demonstration plants will be a key enabler of the required learning process and should be set up to maximise the useful information that can be generated and to ensure its effective dissemination to the wider community. Additionally, Europe needs to ensure that it maximises the benefits that can be derived from initiatives and experiences in other continents, in informing its CCS programme.

In addition to the large-scale commercial and demonstration facilities, smaller pilot- and research-scale CO<sub>2</sub> injection experiments will be needed. Such experiments are cheaper and faster to realise, and can thereby enable the necessary steady progress in the science and technology of CO<sub>2</sub> geological storage and provide forums for competence building. They can be targeted and carefully designed, and instrumented to answer specific questions of interest related to process understanding, development of monitoring technologies and model validation. We envisage that several such experiments are needed in various geological settings and conditions across Europe.

To complement the field-scale injection experiments, laboratory experiments (at small and large scales), and modelling initiatives, will play an important role in building understanding and confidence in predicting the performance of CO<sub>2</sub> geological storage. In particular, predictions of long-term performance rely solely on model predictions and therefore pose high demands on reliable modelling and parameter estimation methods and procedures. Here, various model cross-validation and inter-comparison activities will play an important role.

Estimates of the location and characteristics of Europe's storage capacity are uncertain, but they identify saline aquifers as constituting the major part (80%) of capacity. Relatively few large fields make up a large part of the capacity and should be an early target for better characterisation. This is particularly so as estimated costs of CO<sub>2</sub> storage cover a wide range (significant in respect of the anticipated breakeven costs of CCS) according to the location, capacity and characteristics of storage sites: low-cost sites, typically large fields with good injectivity, will be at a premium, particularly in the early phases of CCS roll-out. Although learning-curve effects may lead to some reduction in characterisation and operation costs

over time, the more dominant effect may be the need to make use of progressively more expensive storage sites as the cheaper ones have been used in early stages.

To develop a more confident understanding of Europe's storage capacity, it is recommended that standardised criteria of storage assessment are developed as the basis for generating the data necessary to create an integrated European Geological Storage Atlas. This initiative must be adequately funded, appropriately at an EU level given that it will be a key underpinning resource to enable progress on CCS in Europe, but may be founded on national initiatives to improve knowledge of storage capacity. The European Commission should take a lead on developing a sufficiently detailed understanding of storage capacity

across Europe, particularly in locations, like the Baltic and North Seas, which are of interest to several countries, and so are appropriately addressed at the EU level.

The risk management approach to storage site authorisation, as outlined in the CCS Directive and guidance documents, is supported. However, further developments are required to establish a practicable framework that can be delivered by site operators and that will provide regulators and the public with sufficient confidence in the long-term security of storage. Specific recommendations have been made in section 5.4 to feed into the ongoing deliberations between the scientific community, regulatory and policy bodies, and CCS stakeholders more generally.

## 6 Alternative approaches

### 6.1 Introduction

In recent decades, various methods have been suggested for carbon sequestration. The criteria for carbon sequestration on a relevant scale are so demanding (sequestration capacity of thousands of gigatonnes of CO<sub>2</sub> and storage time of thousands of years) that there are few alternatives to carbon capture and geological storage. In this chapter, the most prominent alternatives are assessed, such as ocean storage of CO<sub>2</sub>, formation of mineral carbonates, CO<sub>2</sub> use as an industrial product or feedstock, cultivation of algae, and biochar. In addition, this chapter also presents two alternative applications of CCS, namely the use of biomass with CCS, and CO<sub>2</sub> capture from air. A final section draws together conclusions on the alternative approaches.

### 6.2 Ocean storage

The ocean is an important sink in the natural carbon cycle and has a very large CO<sub>2</sub> uptake capacity. Injection of captured CO<sub>2</sub> into the oceans, either dispersed into the water column or disposed of on the bottom of the deep ocean floor as a liquid or hydrate, has therefore been one of the options considered for storage of CO<sub>2</sub>.

However, the increase of CO<sub>2</sub> in the atmosphere over the past 150 years or so has already caused an increase in the uptake of CO<sub>2</sub> into the oceans, which has resulted in a pH drop in the ocean surface water of around 0.1 pH units from the pre-industrial value of about 8.2: the ocean is becoming more acidic. This causes concern for the health of coral reefs and other organisms that use calcium carbonate (IPCC, 2005). Storage of CO<sub>2</sub> in the oceans would eventually add to this acidification: for example, ocean storage of 1,000 Gt of CO<sub>2</sub> would eventually cause a global average pH drop in the oceans of about 0.1 pH (Adams & Caldeira, 2008). Several studies have shown that the raised CO<sub>2</sub> levels would have a negative impact on organisms in the ocean (see, for example, Nilsson et al., 2012). To minimise changes in ocean pH, alkaline minerals such as limestone have been suggested as additives for neutralising the injected CO<sub>2</sub>. However, large amounts of limestone and energy for materials handling would be required for this approach to be effective, and limestone is only soluble in deep ocean waters (Harvey, 2008).

Reducing atmospheric CO<sub>2</sub> emissions would reduce the rate of ocean acidification. Capture and ocean storage of some CO<sub>2</sub> emissions would also reduce acidification in surface waters initially, but would increase it in the deep ocean and after several centuries would lead to much the same result as releasing it to the atmosphere. It would also cause dissolution of carbonates in deep ocean

sediments, which are by far the largest pool of carbon on Earth, while partly neutralising its acidification effect. In addition, large-scale injection of CO<sub>2</sub> into the oceans would probably be harmful to some organisms and would affect the deep-sea ecosystem in ways that cannot at present be predicted. There is a balance between reduced impacts in surface waters and increased impacts in deep waters, but because of the potential negative effects, the OSPAR Commission has adopted a decision to legally rule out placement of CO<sub>2</sub> into the water-column of the sea and on the seabed in the North-East Atlantic (OSPAR, 2007).

### 6.3 Binding as carbonate minerals

CO<sub>2</sub> could be permanently converted into stable and harmless minerals using rocks that contain a reactive form of calcium or magnesium. The metal (calcium/magnesium) oxides and silicates in silicate rocks that can be found in the Earth's crust could in theory bind all the CO<sub>2</sub> that could be produced by the combustion of all available fossil fuel reserves (Lackner et al., 1995). CO<sub>2</sub> storage by mineral carbonation (or, more commonly, 'mineral carbonation') could be done *in situ* by injecting CO<sub>2</sub> into rock formations such as basalt, where the main long-term storage mechanism comes from CO<sub>2</sub> reacting with the rock. In a study by McGrail et al. (2006), the potential for *in situ* carbonation of flood basalts was estimated at 100 Gt of CO<sub>2</sub> in the eastern part of the USA alone. In Iceland, an ongoing pilot project (CarbFix) injects CO<sub>2</sub> dissolved into water into basaltic rock for *in situ* carbonation of CO<sub>2</sub>. Injection was started in January 2012 (Aradóttir et al., 2012).

However, most rocks containing magnesium silicates and calcium silicates are crystalline and have practically no accessible pore space. Therefore, most research effort has been put into *ex situ* carbonation, where the mineral would be mined and processed with CO<sub>2</sub> in a separate plant, producing carbonate minerals and silica as illustrated in Figure 6.1. The products could be disposed of as mine filler materials. Carbonation securely traps CO<sub>2</sub> as carbonates, so there would be little or no need to monitor the disposal sites. As an alternative, *ex-situ* mineral carbonation can be used for the production of construction materials or the fabrication of industrial raw materials.

The conversion of calcium and magnesium silicates into carbonates is an exothermic process that happens spontaneously under atmospheric conditions. However, because calcium and magnesium silicates react very slowly with CO<sub>2</sub>, the process must be accelerated considerably to be of any use in an industrial process. This can be done by increasing the reactivity of the minerals,

Figure 6.1 Material streams related to the concept for *ex situ* mineral carbonation. Source: IPCC, 2005.

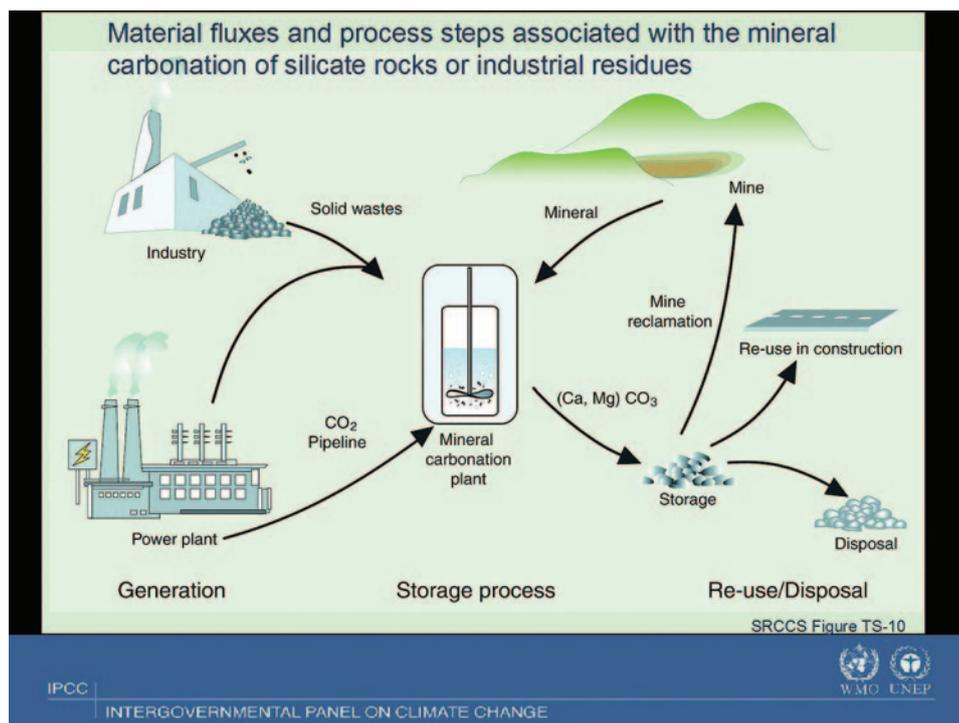

by adding heat and/or by using a high CO<sub>2</sub> pressure. This makes the process energy demanding, because it requires fine grinding of the mineral to increase its reactivity, and in some cases the addition of chemicals or heat treatment of the mineral. The most successful process so far reacts a slurry of mineral, water and additives with pressurised CO<sub>2</sub> (40–150 bar) at a temperature of 100–185 °C (O'Connor et al., 2005). The minimum operating costs have been estimated as €60 per tonne CO<sub>2</sub> avoided, depending on the reactivity of the rock (Gerdemann et al., 2007). More recent cost estimates suggest a minimum cost of €80–130 per tonne CO<sub>2</sub> avoided (Styring et al. 2011). However, these figures do not include the costs of CO<sub>2</sub> capture and transport, which would also be needed.

The largest environmental impact from *ex situ* mineral carbonation is expected to arise from the mining of the minerals. To store 1 tonne of CO<sub>2</sub>, approximately 2–4 tonnes of mineral are required. This implies that one large-scale mine would be needed to provide the rock required for carbonation of the CO<sub>2</sub> from each large-scale power plant with CO<sub>2</sub> capture. It is possible and likely that other minerals and metals would be extracted from the rock in conjunction with a mineral carbonation facility, but so far no economically feasible carbonation process has been developed.

Alkaline industrial wastes and by-products, such as steelmaking slags and process ashes, also have high contents of magnesium and calcium. In general, these industrial waste streams have a higher reactivity than naturally occurring calcium and magnesium minerals, hence cheaper processes can be used for fixing the CO<sub>2</sub>

as carbonate (Quaghebeur et al., 2010). The CO<sub>2</sub> storage capacity, however, is much more limited because of the availability of suitable waste streams. The global potential is of the order of a few hundred million tonnes of CO<sub>2</sub> per year.

Carbonation of steel slag is one of the most promising CO<sub>2</sub> use options in terms of technical feasibility and capacity. But its current production of 400 Mt/year (World Steel Association, 2010) would only correspond to a total global storage capacity of 3 Gt CO<sub>2</sub> for the next 40 years, which could be improved somewhat by using stockpiled steel slag.

Although a few processes using industrial residues have already reached the pilot stage, (for example the Alcoa bauxite residue carbonation plant in Australia), these processes are not alternatives to geological storage, as their storage capacity is much lower. However, these processes can be used for production of construction materials, such as aggregate and masonry blocks, and filler materials. Hence, these processes allow industrial wastes to be turned into valuable products, while saving virgin raw materials and avoiding CO<sub>2</sub> emissions.

#### 6.4 CO<sub>2</sub> as a chemical product or feedstock

Several industrial processes use CO<sub>2</sub> as a feedstock, and R&D is being undertaken to increase such applications. The current industrial use of CO<sub>2</sub> is about 115 Mt/year worldwide, of which the production of urea is the largest consumer of CO<sub>2</sub>, accounting for 60% of the

total (IPCC, 2005). Other uses include the production of intermediate chemicals required by the chemical industry, such as carbamates, carboxylic acids, inorganic complexes and polymers. CO<sub>2</sub> is also used in the food industry and as a solvent. It is important to point out that CO<sub>2</sub> is eventually released back to the atmosphere at the end of the life cycle of the product, which can range from days to decades (and in some cases centuries). In contrast to CCS, CO<sub>2</sub> use can contribute to capture costs, but revenue generated from selling CO<sub>2</sub> for re-use is likely to be moderate and subject to downward price pressure because of an anticipated supply surplus (Parsons Bickerhoff, 2011), and the potential is restricted.

Recent estimates of the maximal use of CO<sub>2</sub> as a feedstock for chemical products are around 180–230 Mt/year worldwide (VCI and DECHEMA, 2009; Styring et al., 2011), which is a small potential contribution in relation to global anthropogenic CO<sub>2</sub> emissions in 2009 of around 30 Gt. The production of urea is the largest potential consumer of CO<sub>2</sub>, with a maximum use potential of around 100 Mt/year. However, many of these manufacturing processes cannot be regarded as carbon-negative processes, because there are large energy requirements for many of them. For example, in urea production, CO<sub>2</sub> is taken from the process of reforming natural gas (or a similar feedstock) to produce ammonia, so no external CO<sub>2</sub> is captured: CO<sub>2</sub> is produced and then used within the same industrial process. In the case of reforming natural gas, a small surplus of ammonia is produced, which could be used with externally captured CO<sub>2</sub> to produce more urea. This potential is 5–30 Mt CO<sub>2</sub>/year (Global CCS Institute, 2011a), which is considerably less than the maximum use potential presented above.

CO<sub>2</sub> can also be used as a feedstock for production of fuels such as methanol and synthetic liquid hydrocarbons. For example, VCI and DECHEMA (2009) estimate that a maximum of 2 Gt/year CO<sub>2</sub> could be used for fuel synthesis, but state also that even more CO<sub>2</sub> would be released in the process, unless renewable sources or nuclear power could provide hydrogen for the conversion process. Although the amount of energy required to produce liquid synthetic fuels exceeds the recoverable energy, they allow storage of energy and can be used in transport applications. Their production may be supported by renewable energy sources as a way of balancing supply and demand in future electricity systems dominated by variable renewable energy sources.

A broader usage of CO<sub>2</sub> is likely to get a favourable response from the public, and the concept of carbon capture, use and storage is being promoted by the Carbon Sequestration Leadership Forum, although use is focused mainly on enhanced oil recovery. However, an increased use of CO<sub>2</sub> would not lead to a reduction of CO<sub>2</sub> emissions, unless the inventory of the products

containing CO<sub>2</sub> is increased or the energy used to produce the chemical products comes from renewable sources (but the 'opportunity cost' of those renewable energy sources in respect of CO<sub>2</sub> savings elsewhere in society needs to be taken into account). Even then, the contribution to climate change mitigation is likely to be rather limited, as concluded also in a recent study commissioned by the Global CCS Institute (Parsons Brinckerhoff, 2011).

## 6.5 CO<sub>2</sub> for cultivation of algae

Microalgae are microscopic organisms (ranging in size from a few micrometres to a few hundreds of micrometres) that have potential for cultivation as energy crops or as a source for renewable polymers. Research has shown that flue gas from coal- and gas-fired power plants could be used for providing CO<sub>2</sub> for microalgae cultivation (Styring et al., 2010). The algae consume the CO<sub>2</sub> and are harvested for production of biomass for power production or valuable products including bio-oils and proteins, high-value chemicals and ingredients, food and feed, fertilisers and fuels. Cultivation of microalgae takes place in open ponds or in closed/semi-closed reactors to which water, nutrients and CO<sub>2</sub> are supplied. The oil productivity of algae can presently range between 12,000 and 30,000 litres of oil per hectare<sup>‡</sup> per year, which is far higher than that of palm oil and rapeseed oil (BIOREF-INTEG, 2009). There are possibilities for using the heat from the flue gases for maintaining the culture temperature and to convert the NO<sub>x</sub> in the flue gas to nutrients.

At this stage of development, the technology is not ready for commercial implementation; significant research, development and demonstration, and investments are required for the technology to become economically viable. The current net energy requirement for production of algae is three to four times higher than that of terrestrial crops because of the energy requirements for mixing, harvesting, concentrating and drying or refining the algal biomass. The land usage area is slightly lower than that for agricultural crops: about 80 t per hectare per year (Styring et al., 2011). Considering that the CO<sub>2</sub> fixation capacity per tonne of algal biomass is roughly 1.8 t CO<sub>2</sub> (Styring et al., 2011), the fixation of the CO<sub>2</sub> emitted by a 600 MW<sub>e</sub> coal-fired power plant (about 4.4 Mt of CO<sub>2</sub>/year) would require a surface for algal cultivation of about 300 km<sup>2</sup>.

Growing algae on non-cultivable land, and even on the sea, would limit competition for land use with food production or the cultivation of other energy crops. However, to use microalgae for biofuels, anticipated production costs need to be substantially reduced and the scale of production needs to be increased significantly. Co-production of commercial biochemicals with higher value than bio-energy, such as lipids, proteins and

---

<sup>‡</sup> 1 hectare = 10<sup>4</sup> m<sup>2</sup>.

polysaccharides, might result in plants for cultivating microalgae becoming economically viable in the long run.

The potential contribution of algal production in Europe will be limited by high costs, energy inputs, land requirements and residual CO<sub>2</sub> emissions. Niche applications may arise for co-production with higher value bio-chemicals, assuming that research and development activities over the next 10–15 years are successful in realising viable processes at commercial scale.

## 6.6 Biochar

Storing carbon as biochar has recently been suggested as a method for lowering CO<sub>2</sub> in the atmosphere (Lehmann, 2007). Biomass could be converted by pyrolysis, in which biomass is heated to 350–700 °C in the complete or partial absence of oxygen. This produces many different components: gaseous components that can be converted into energy carriers such as electricity, bio-oil or hydrogen, and biochar as the remaining solid phase. Biochar is the solid carbon-rich residue from pyrolysis, which is often used to pre-dry biomass feedstock or is sold as charcoal briquettes. Biochar can also be added to agricultural soils, where it has two main properties:

- as the most stable known form of organic carbon in soils, it functions as a storage mechanism for (biogenic) carbon; and
- it tends to increase crop yield, typically by 10–40% depending on soil properties, probably because of its large sorption capacity, retaining water and nutrients, although the mechanisms are not well understood.

Typically, about 50% of the carbon in the biomass is converted into biochar that can be returned to the soil.

According to Woolf et al. (2010) the global carbon sequestration capacity of biochar is large: 6.6 Gt CO<sub>2</sub> equivalent per year or 480 Gt CO<sub>2</sub> in the next 100 years (as a theoretical maximum based on exclusive use of all biomass that can be harvested without endangering food security, habitat or soil conservation). Others, for example the Royal Society (2009), have arrived at a less optimistic view. They conclude that, at best, biochar could only make a small-scale contribution to mitigating climate change, given potential conflicts with food for land use and possible advantages of burning biochar as a replacement for fossil fuels rather than burying it. Also, biochar does not store CO<sub>2</sub> permanently: the carbon is expected to be stored for timescales of decades to centuries (Schmidt et al., 2011). The stability of biochar depends on the pyrolysis conditions, and may be affected by interactions with minerals and by soil conditions.

In considering the potential use of biochar for climate change mitigation, alternative uses of the available

biomass for renewable energy production need to be considered, taking a life-cycle analysis approach. According to Woolf et al. (2010), the benefit of producing biochar instead of biomass combustion is greatest (64–79% better) when biochar is added to marginal lands and the energy produced by pyrolysis is used to offset natural gas, renewable or nuclear energy. But in those geographical regions that have both a naturally high soil fertility and good prospects for switching from coal to biomass in power production, bioenergy yields up to 16–22% greater climate change mitigation impact than biochar. A mixed strategy according to local circumstances will maximise the overall climate change mitigation potential. The application of CCS to biomass combustion for power production (potentially combined with heat production), not considered by Woolf et al. (2010), may weigh the choice in favour of biomass combustion.

Mild pyrolysis of biomass (torrefaction) is also used for improving the fuel quality of biomass for combustion and gasification applications. Torrefaction combined with densification gives a very energy-dense, solid fuel carrier (the biochar) that can be combusted at higher co-firing rates and reduces handling, transportation and storage costs. However, as long as fossil fuels are mined and extracted for providing energy, it seems unlikely that biochar would be produced in this way for storage in the ground.

A recent EASAC study of sustainable biofuels (EASAC, 2012) has concluded that the availability of biomass in Europe for energy use is rather limited when competing use of land for food production and the ecosystem functions of agricultural and forestry wastes are taken into account. Competing uses will further reduce the proportion of this biomass that could be appropriately used for biochar. This, together with the limited carbon storage times offered by biochar, suggests that it may only find niche applications in Europe, acting as a complementary technology rather than an alternative to CCS.

## 6.7 Biomass with CCS

Along with biochar discussed in the previous section, and direct capture of CO<sub>2</sub> from the air discussed in the next, the use of biomass as an energy source in association with CCS has the potential to remove CO<sub>2</sub> from the atmosphere. Options include the following.

- The production of liquid or gaseous fuels from biomass, typically for transport applications. For large-scale production (as distinct from small-scale anaerobic digestion of wastes or farm by-products) the carbon in the biomass is distributed between the produced fuel (to be released as CO<sub>2</sub> to the atmosphere if used as a transport fuel), a relatively pure CO<sub>2</sub> stream which is readily captured, and CO<sub>2</sub> from the combustion of residues for heat/power generation, which requires a capture process to

be installed to avoid release to the atmosphere. The relative proportions of these streams differ substantially between processes.

- The combustion or gasification of biomass directly for power, heat, or combined heat and power generation. The three main options for CO<sub>2</sub> capture, discussed in Chapter 3, can be applied, albeit with some process modifications to address the particular characteristics of the biomass.
- Co-firing of biomass with coal in a plant equipped with CO<sub>2</sub> capture. The proportion of biomass that can be used depends on the characteristics of both the biomass and plant.
- Capture of CO<sub>2</sub> from pulp and paper manufacturing plants, where a large part of the CO<sub>2</sub> emissions originate from the combustion of black liquor in large boilers.

One of the main problems for biomass-related CCS application is scale: CO<sub>2</sub> fluxes will typically be smaller than those applying to commercial fossil-fired power plants, which will increase capture and transportation costs. Another is location, determined by the need to be close to biomass resources (otherwise cost and energy requirements for biomass transportation may be prohibitively high) rather than to CO<sub>2</sub> transport networks and storage facilities. The scale problem is less of an issue for co-firing in a large commercial fossil-fired plant, but considerations of biomass proximity will remain. The close integration of modern pulp and paper manufacture plants, layout restrictions, lack of heat (in paper mills) and flue gas impurities are the main challenges in applying CCS to existing pulp and paper plants.

For the contribution that use of biomass with CCS could make to climate change mitigation in Europe, a key question, and one that continues to attract heated debate, is the amount of biomass in Europe that can sustainably be diverted to energy use. A recent joint study by the European Biofuels Technology Platform and ZEP (2012b) indicates that biomass with CCS could remove up to 800 Mt of CO<sub>2</sub> annually from the atmosphere by 2050 (rather more than the annual carbon sink in EU forests of around 600 Mt (Manitau et al., 2010)). Biomass use to support this figure would be around 2.5 times that currently used for energy in Europe (ZEP, 2012b), which contributes around 5% of Europe's total primary energy supply. This figure assumes that all the biomass is processed through dedicated gasification or combustion facilities, or is co-fired with fossil fuels, with capture, and is not processed to biofuels, which results in lower rates of capture. Also, it assumes that the cost issues associated with scale and location, as previously alluded to, can be overcome.

The European Biofuels Technology Platform and ZEP (2012b) estimate seems to be rather optimistic. Recent studies by EASAC (2012) and by the German National

Academy of Sciences Leopoldina (2012), have questioned the amounts of biomass that can sustainably be used for energy in Europe given competing uses of land for agriculture and to sustain biodiversity, the need to recycle nutrients to the soil (in the case of agricultural and forest residues), and resource requirements such as water and fertilisers for biomass cultivation. The European Environment Agency Scientific Committee on Greenhouse Gas Accounting (2011) has pointed to the need to look at the opportunity cost of land use for biofuels, which would include the option of simply growing trees.

On balance, it seems that biomass with CCS may make a modest but useful contribution to climate change mitigation in Europe, if the cost issues associated with scale and location can be overcome. In the USA, an integrated system for collecting CO<sub>2</sub> from an ethanol production plant and injecting it into a saline aquifer for storage recently started up in Decatur, Illinois. The CO<sub>2</sub> is a by-product from processing corn into fuel-grade ethanol. The plant collects and injects 1000 t of CO<sub>2</sub> per day, amounting to about 300,000 t annually (Global CCS Institute, 2012d).

## 6.8 Direct capture of CO<sub>2</sub> from the air

Direct capture of CO<sub>2</sub> from the air is one of a few CO<sub>2</sub> removal techniques, which remove CO<sub>2</sub> from the atmosphere. CO<sub>2</sub> is selectively extracted from ambient air by passing it over a suitable chemical sorbent. The CO<sub>2</sub>-depleted air is released to the atmosphere, whereas the selective sorbent is regenerated and re-used, after releasing the CO<sub>2</sub> as a concentrated stream that can be then pressurised and ultimately stored (APS, 2011).

Direct air capture faces several challenges. The low concentration of CO<sub>2</sub> in ambient air (350 parts per million compared with 140,000 parts per million in the flue gas of a coal-fired power plant) implies that a strong sorbent has to be used, for example strongly alkaline solutions instead of amine solutions as in post-combustion capture, and that a huge amount of air has to be treated in an industrial facility to remove significant amounts of CO<sub>2</sub>. As an example, removing from air the same amount of CO<sub>2</sub> produced in a 1 GW coal-fired power plant would require treating about 500,000 m<sup>3</sup> of air per second (assuming a reasonable capture rate of 50%). If air flows through the absorber at 2 m/s, an absorber cross section of 300,000 m<sup>2</sup> would be needed to accomplish this task (Mazzotti et al., 2013).

The strong binding between CO<sub>2</sub> and sorbent, which is required because of the low CO<sub>2</sub> atmospheric concentration, leads to downstream regeneration steps that are very energy intensive, both in the case of liquid sorbents, typically highly concentrated sodium hydroxide solutions, and solid sorbents, for example ion exchange resins or functionalised silica sorbents. Consequently, only low-carbon energy sources are possible for powering direct air capture systems, otherwise consequent CO<sub>2</sub>

emissions will probably exceed the CO<sub>2</sub> captured. The opportunity cost of those low-carbon energy sources in respect of displacing high-carbon energy sources elsewhere in society also needs to be considered.

Finally, from an operational point of view, a direct air capture plant would have a major environmental impact because of its scale, the amounts of potentially aggressive chemicals used and the amount of water used in the process (a large quantity of which might be lost through unavoidable humidification of the treated air, which will leave the process fully saturated with water). Moreover, the performance of the direct air capture process will be strongly affected by local (and variable) environmental conditions, for example the relative humidity of the air. It has also to be emphasised that, once captured from air, the CO<sub>2</sub> has to be stored: that is, it faces the same challenges and costs of storage as conventional CCS.

The physical scale and complexity of the direct air capture system lead to much higher costs per tonne of CO<sub>2</sub> avoided (i.e. the net amount of CO<sub>2</sub> removed from the atmosphere, when parasitic emissions are taken into account) than in the case of post-combustion capture. APS (2011) estimates that the cost per tonne of CO<sub>2</sub> avoided of a direct air capture system would be about eight times larger than the corresponding cost of a post-combustion capture plant. It is worth noting that no demonstration or pilot-scale complete direct air capture plant has yet been deployed.

It can safely be concluded that direct air capture may play a role in climate and energy policies only when large CO<sub>2</sub> sources (power and industrial plants) have been almost completely eliminated on a global scale.

## 6.9 Conclusions and recommendations on alternative approaches

The potentials of the alternatives to mainstream CCS considered in this chapter may be summarised as follows.

- Although storage of CO<sub>2</sub> in the oceans is relatively straightforward technically, and storage capacity in theory is very large, in practice it is unacceptable because of the potential adverse effects on marine ecosystems. Similarly, the theoretical capacity of binding CO<sub>2</sub> as mineral carbonates is very high and storage would be the closest of any of the options to 'permanent'. But high costs, energy inputs and environmental impacts are likely to rule it out other than in exceptional circumstances, or unless a big technical breakthrough is made. One exception, potentially able to make a small contribution to climate change mitigation, is the use of alkaline industrial wastes (for example, slag from steelmaking and bauxite residue from alumina production).

- The potential contributions of biochar, algae production and use of CO<sub>2</sub> in chemical feedstocks and synthetic fuels are all restricted to very modest levels by a range of factors. More significantly, these options only sequester the CO<sub>2</sub> for limited periods before it returns to the atmosphere.
- Similarly, use of biomass with CCS may make a modest contribution to climate change mitigation but will be limited by issues of scale and location, and alternatives such as just growing trees may be more effective on timescales of immediate concern.
- Given its very high costs (as mentioned above, eight times those of post-combustion CCS per tonne of CO<sub>2</sub> removed), energy requirements and environmental impacts, direct capture is a 'last resort' technology which would only sensibly be deployed when CCS has been fitted to all major point sources of CO<sub>2</sub>.

In the near future, there seems to be no feasible (either in technical, economic or environmental respects) alternative approaches to geological storage of CO<sub>2</sub>, although there are several interesting concepts being developed that could provide some welcome, but limited, additional means for reducing greenhouse gas emissions in the future. Carbonation of rocks would provide the ideal means for CO<sub>2</sub> storage, but no feasible process concept has been found yet.

The technologies for biochar, biomass with CCS, waste carbonation, algae cultivation and CO<sub>2</sub> use in chemical processes have already reached the pilot or demonstration stage. These methods are applicable only if certain conditions are met and are likely to be restricted to niche applications. Their potential for reducing greenhouse gas emissions is therefore limited. Although none of them are comparable in terms of CO<sub>2</sub> abatement capacity to geological storage, which provides a significantly larger capacity, they are important concepts for sustainable development, and can play an important role in decarbonation of industrial processes.

Currently, technologies such as the use of biomass with CCS, waste carbonation, biochar and CO<sub>2</sub> use are not included in the EU ETS. Although the EU allowances price is currently low, it is expected to rise in the future and would therefore be an important driver for developing these options into commercial processes. Therefore, these options should be included in the EU ETS, under the condition that the mitigation effect from the life cycle of these options (especially in the case of CO<sub>2</sub> use) is significant, and can be measured and proved.

Consideration should be given to the potential enhancement of public understanding and acceptance of CCS by including CCS applied to biomass-based plants for generating heat and power in the overall mix of technologies comprising the CCS portfolio.

## 7 Public perception and engagement

### 7.1 Introduction

This chapter examines the topic of public perception and engagement, which has already emerged as a key factor in determining the prospects for CCS, and is likely to become more important as deployment of demonstration and commercial plants nears. Current attitudes and experiences of public engagement are reviewed in section 7.2, followed by a summary of prescriptions for good practice in public engagement on CCS in section 7.3. A concluding section reflects on the implications for CCS in Europe.

As mentioned earlier in the report, across Europe, the period experienced by major infrastructure projects for planning and gaining consent regularly exceeds 10 years (Element Energy, 2010). Similarly, electricity transmission enhancement projects in Europe face long delays: the time from the start of planning to the issuing of the building permit for a Trans-European Energy Networks (TEN-E) priority electricity transmission project is on average 7 years, with 25% of projects requiring more than twice this time (MVG Consulting, 2007). Streamlining and improving procedures, providing more transparency and ensuring open and transparent debates at local, regional and national levels to enhance public trust in, and acceptance of, the installations is seen as a priority by the European Commission (2010b) to address these problems.

Similarly for CCS, communications with the public are considered likely to play a crucial part in determining what role CCS plays in Europe in the coming decades and the rate at which CCS infrastructures can be developed (Corry and Reiner, 2011). If CCS is to play a significant role in Europe's energy mix in 2050, initiatives on public engagement on CCS will need to be undertaken at international and national levels, initially to establish whether CCS is supported by societies as a climate change mitigation option, and then to generate awareness and positive attitudes towards CCS at a societal level, and locally where CCS infrastructures are to be established to generate local support. Studies (for example, Upham and Roberts, 2010) have shown that public concerns relate primarily to CO<sub>2</sub> storage facilities (particularly onshore) rather than to capture. Concerns about CO<sub>2</sub> transport are intermediate between the two.

A distinctive challenge for CCS is that first the reality of climate change and the need to do something about it generally must be accepted, before a debate can be had about whether CCS is an appropriate response (Hammond and Shackley, 2010). Upham and Roberts (2010) state, 'Given the high level of mistrust in scientific knowledge relating to climate change, convincing the

general public of the benefits of CCS, and in particular those who live and work in areas which are likely to be affected by deployment presents a significant challenge'. This challenge is exacerbated because the people who accept the reality of climate change and the urgency of tackling it, tend to favour other solutions such as renewable energy technologies and reduced energy use through improved efficiency (Reiner, 2008; Kuijper, 2011).

A further challenge arises from the geographic separation of benefits (in the form of jobs and investment, which are mainly located at the capture facility) and (perceived) risks, primarily associated with the storage site, but to a lesser degree with the transport infrastructure (Kuijper, 2011). The 'local value proposition' for the community being asked to host the storage facility, an important factor in determining its acceptance or rejection, will therefore typically be weak (Kuijper, 2011): 'the benefits are mainly for others, somewhere else and later, and the (perceived) risks and impacts are here and now'. A similar problem often arises for activities of climate change mitigation more generally.

### 7.2 Current attitudes and experience

Concern has been expressed that insufficient work has been done to develop a baseline understanding of public attitudes to CCS and how different actors respond to information on it (Hammond and Shackley, 2008). To the extent that surveys have been undertaken across Europe, they show generally low levels of awareness of CCS, although they are growing slowly (Desbarats et al., 2010). The Eurobarometer (2011) survey in 12 EU countries revealed that just one in ten of the respondents had heard of CCS and knew what it was. Initiatives to engage the wider publics in Europe on CCS have arguably not moved as quickly as might be expected considering the scale of deployment envisaged by proponents and in EU energy policy (Hammond and Shackley, 2008).

There are some variations in attitudes and awareness between countries. The Netherlands stands out in the Eurobarometer (2011) survey as having substantially higher levels of awareness (52% having heard of CCS and knowing what it is) than other European countries, where awareness ranged between 3 and 13%. Levels of public awareness in Norway (not covered by the Eurobarometer survey) are also reported as high (Schumann, 2010). The percentage of people polled who thought that CCS would be effective in fighting climate change ranged from 23% in Germany to 56% in the Czech Republic. Differences in awareness and attitudes are not unexpected given differences between countries in cultural framings, political priorities, energy-related pre-conditions, and the maturity of debates on climate

change and on CCS (Meadowcroft and Langhelle, 2009). It is of concern that, in some countries, CCS has become a 'political football' where opposition (usually) or support for a CCS project is adopted as a source of political advantage rather than on the merits of the project (Hammond and Shackley, 2010; Chrysostomidis et al., 2012)

However, focus groups conducted in six EU countries (Belgium, Germany, the Netherlands, Poland, Spain and the UK) identified a level of commonality in respect of opinions and concerns (Upham and Roberts, 2010). CCS was generally seen as an uncertain, end-of-pipe technology that will perpetuate fossil-fuel dependence. Furthermore, the participants were far from convinced that CO<sub>2</sub> can be stored securely for thousands of years. More generally (Shackley et al., 2007), reasons for opposition to CCS tend to arise from concerns about risks to the environment and safety, and because CCS is seen as diverting funds from more attractive responses to climate change, in particular renewable energy technologies and energy efficiency (it is a 'zero sum game'). For non-governmental organisations opposed to the continued use of fossil fuel, CCS may be seen as an 'Achilles heel' (as radioactive waste disposal is for the nuclear industry) and consequently is tactically an appropriate focus of opposition (Reiner and Nuttall, 2011).

Low levels of awareness mean that opinions can be unstable and are liable to change quickly (Best-Waldhober et al., 2009; Shackley and Evar, 2009). This presents both an opportunity and a threat to CCS deployment in Europe: an opportunity because there is more scope to influence views than if opinions are already formed; and a threat, in that if views shift to be negative (particularly if associated with being in the 'fear/worry zone' (Vercelli, 2010)) they can be very difficult to change.

Shifts in opinions as individuals become more familiar with CCS through presentation of information on CCS in focus groups, etc. have proved more difficult to predict: experience has been mixed. For example, in the focus groups discussed in Upham and Roberts (2010), attitudes shifted from uncertain and neutral, to negative, whereas in the large group process undertaken in Perth, Australia, described in Ashworth et al. (2009), support for CCS increased. People's perceptions and their reaction to new information is likely to be shaped by their broader values and world-views, which may explain why the focus groups were difficult to predict, and different results were found in the distinctive cultural contexts of different countries (see, for example, Kahan et al., 2011; Whitmarsh, 2011).

Also, opinions expressed in national-level surveys are not necessarily good indicators of reactions locally when communities are faced with the prospect of hosting a storage or transport facility (Chrysostomidis et al.,

2012). However, as a general rule it is difficult to build acceptance of a proposed CCS facility at a local level if there is little awareness, understanding and consensus at a national level.

At the local level in Europe, experiences of public engagement so far have been mixed: for example, they have been positive at the Ketzin test site in Germany and the Lacq CCS pilot plant in France, but met concerted public and political opposition in Barendrecht in the Netherlands. For both the Ketzin and Lacq projects, factors leading to positive outcomes of public engagement have been identified as being early and proactive engagement, and willingness to discuss issues such as the potential for CO<sub>2</sub> leakage openly (see, for example, McDaniels and Bowen, 2010). A major failing of the Barendrecht project has been identified as a lack of alignment among key government and project development players (Ashworth et al., 2011b).

As communities engage with the prospects of a CCS facility, developing trust in the institutions and decision processes is often found to be a more important factor in establishing stakeholder support than building understanding of the technical issues (Shackley and Evar, 2009; Hammond and Shackley, 2010). This can be particularly influential where the trust has been built up over many years by a developer that is already well-embedded in a community and has a track record of reliability in previous interactions (Bradbury, 2012). Experience from seven 'Regional Carbon Sequestration Partnerships' in the USA (Hammond and Shackley, 2010) indicates that for a developer to build stakeholder trust it must do the following:

- deliver truthful information and a safe project;
- operate a transparent and fair decision process;
- be accountable should things go wrong; and
- treat the local public fairly in the distribution of economic benefits and any hazards.

However, information from developers, industry more generally and governments tends to be mistrusted: researchers in universities and independent research institutes, and non-governmental organisations, are more trusted sources of information (Eurobarometer, 2011). For the last bullet point, some form of compensation scheme, which is accepted as equitable, may well be required in relation to appropriate economic rents to landowners under whose land CO<sub>2</sub> is stored, and in respect of any impact on property prices.

The public often views risks more 'expansively' than project developers, integrating technical and non-technical considerations (Bradbury et al., 2011). Such intuitive 'risk perceptions' have been found from

extensive research to position risks as greater and of more concern if they are characterised by two factors:

- 'dread': perceived lack of control of the activity, fatal and catastrophic potential from accidents, and uneven distribution of risks and benefits; and
- 'unknown': hazards difficult to observe, activities or technologies that are new to science, and delayed manifestation of harmful consequences (long-term effects).

CCS has some of these characteristics. Perceived risks should be treated as just 'as real' as risks derived from technical evaluations in public engagement activities: if they are not addressed, they can soon transform into opposition (NETL, 2009b). However, dangers may be exaggerated, particularly by opposition groups and the media, and an important role for the independent scientific community is to impart a balanced view of the expected scale and significance of phenomena in public debates.

Importantly, publics' support or opposition to CCS does not just derive from an evaluation of the perceived risks, but is also bound up with individuals' and groups' values and world-views – 'a product of their whole life background' – which includes concerns about issues such as the fairness or justice of the spatial distribution of any potential side-effects of CCS, what is the appropriate way to treat the Earth, who has the right to decide how to manage a particular space, etc. (Mabon et al., 2012).

### 7.3 Good practice in public engagement on CCS

Although concerns have been expressed that public engagement and communication on CCS have attracted insufficient resources and have lacked coordination (Reiner, 2008; Corry and Reiner, 2011), guidelines on good practice in stakeholder engagement have emerged in recent years (for example, NETL, 2009b, World Resources Institute, 2010, Ashworth et al., 2011a). They focus on local engagement in connection with a prospective CCS facility, rather than on national level debates about the merits of CCS and its role in national plans to mitigate climate change. However, some concerns have been expressed about their usefulness in that they do not address the deeper issues of public perceptions of CCS and the broader issues of climate change, and that the context can be radically different between locations (Mabon et al., 2012)

Such national debates are important precursors for local engagement as they 'lay the ground', and local acceptance cannot be addressed in isolation from the broader political context (Kuijper, 2011). Also, local disputes can otherwise substitute for debate that should be undertaken at national level (Owens, 2004). However,

there is currently a 'chicken and egg' problem in that national debates may be better grounded in light of experience with operational CCS facilities. Typically, local engagement may appropriately be led by the organisations seeking to develop a facility, and national debates may be led by Governmental bodies.

At the local level, Kuijper (2011) describes a three-stage process starting with 'understand the playing field' (careful analysis of the stakeholders' concerns and influence), followed by 'define the local value proposition' (why the local community should support the CCS facility) and then 'develop the public acceptance strategy' (in collaboration with stakeholders). The need for an initial stage of analysis and evaluation is emphasised more generally (Desbarats et al., 2010; Ashworth et al., 2011a; Bradbury et al., 2011) to identify the priority issues so that the project can be designed to address them and to deliver desired benefits. The analysis should recognise that stakeholders with influence can come from well beyond the immediate locale (NETL, 2009b).

Key elements of the good practice prescribed by these various sources include the following.

- Engagement should start early, be a two-way dialogue (not one-way messaging), and involve transparent and frequent communication using multiple and good-quality information sources and forums, both formal and informal. The dialogue should not be limited to the technological and engineering aspects of the development, but should be situated within a wider debate about uncertainties, priorities, policy choices, alternative technologies and societal values. It is vital to explain the rationale for CCS.
- Public outreach should be an integral component of project management, enabling the project to be adjusted to its social context. Communication/outreach experts should be integral members of the project team.
- National, state and local contexts need to be aligned, i.e. support and coordination is required between all three levels of government, and an appropriate regulatory framework should be in place.
- It is helpful to involve experts who will be perceived to be independent, potentially including the establishment of a panel of independent scientists who will comment on proposals and with whom the public can engage. Where possible, it is helpful to get local opinion leaders 'on side' as they can be useful spokespeople.

Hammond and Shackley (2010) point to the need for a stepwise progression towards a CCS facility as illustrated in Figure 7.1.

Figure 7.1 Stepwise approach to public acceptance of CCS facilities. Source: Hammond and Shackley, 2010.

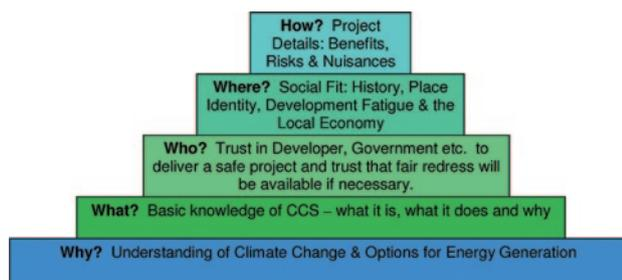

A consistent message is that engagement cannot be rushed, and sufficient time should be built into project schedules (NETL, 2009b; Ashworth et al., 2011a). Similarly, engagement should have substance: a sense of empowerment of the local community (a voice that is heard) is a strong influence over whether it will embrace an unknown technology (Hammond and Shackley, 2010). People expect procedural justice: that their concerns are listened to and taken seriously (Desbarats et al., 2010). However, in many cases, the storage location is fixed and equipment choices are limited and straightforward, and therefore participatory approaches (including stakeholders in design decisions) are only possible for a limited number of decisions (Kuijper, 2011).

This represents a tension for CCS projects. The resolution of a similar tension in radioactive waste disposal has led to the adoption in most countries with a nuclear programme of a 'volunteer' approach to establishing the locations of disposal facilities: a local community must express its willingness to host the facility and has the right to pull out until the project is quite far advanced. Although most countries will have just one or two national facilities for disposal of radioactive waste, countries adopting CCS will require several or many. It is therefore debatable whether such volunteer approaches could work for CCS: they do, in any case, take a long time, stretching into decades in some instances. Such timescales would severely limit the contribution that CCS could make in Europe.

A final observation is that even well designed and implemented public engagement processes do not guarantee the eventual successful implementation of an infrastructure project such as a CCS facility.

## 7.4 Conclusions and recommendations on public engagement issues

More concerted initiatives are needed at EU and national levels to debate the value of CCS in the context of climate

change mitigation strategies, and consequently to build awareness and acceptance of the potential of CCS as a climate change mitigation option. Such debates would usefully be informed by a better picture of the capacities and locations of Europe's storage sites. In the absence of a more proactive and strategic approach, negative sentiments and opposition may become entrenched, as has happened already in some countries and in some particular locations where CCS facilities have been proposed, which may severely limit the potential contribution of CCS irrespective of its technical and economic merits.

Such initiatives may appropriately be taken in parallel with the demonstration projects currently being developed, which should help to ground the debate and to build familiarity over time with what CCS constitutes in practice. An important role of the demonstration plants will also be to build experience of public engagement approaches at the local level. Effective methods for synthesising and disseminating the lessons learned and identifying good practice will be needed.

Looking beyond the demonstration plants, there is a case that the social setting for CO<sub>2</sub> storage facilities should be given greater weight, alongside the suitability of the geological setting and location in relation to capture sites, in deciding where to locate CO<sub>2</sub> storage facilities. From the viewpoint of building public acceptance, an overall roll-out strategy in Europe might initially prioritise offshore locations (which experience so far suggests attract less opposition) and sites that already host relevant industrial activities (for example, oil and gas operations) which may be more receptive to CCS. If a track record of success can be built in these locations, roll-out to others may follow in due course.

Public engagement at national and EU levels to establish the social context for CCS, and at local levels in respect of individual facilities, needs to be given sufficient time and should have substance in the sense of allowing 'no' as the answer either nationally or locally. This will impact on the rate at which CCS can be deployed in Europe: but the significance of that impact cannot currently be estimated. By ramping up engagement activities sooner rather than later, an earlier understanding can be established of the extent to which issues of public acceptance will prove to be a key determinant of CCS's contribution to mitigating climate change in Europe.

## 8 Prospects for CCS in Europe to 2050

This chapter first considers the economics of CCS, then reviews the broader range of factors that will influence the prospects for CCS in Europe to 2050, and finally reflects on the consequences for the prospects of CCS to 2050.

### 8.1 Economic considerations

Table 8.1, derived from ZEP (2011a) and summarising information previously discussed in Chapters 3–5, illustrates the contributions of capture, transport and storage to the costs of avoiding the emission of 1 t of CO<sub>2</sub> due to the application of CCS. The baseline against which costs are evaluated is the respective coal- or gas-fired station without CCS.

Capture costs for natural gas combined cycles with post-combustion capture are sensitive to the gas price, hence the range of capture costs presented reflects the range of possible gas prices in 2020 as anticipated in European Commission (2008a) and reproduced in ZEP (2011a). From the ZEP study, costs for avoiding the release of a tonne of CO<sub>2</sub> due to the application of CCS from natural gas combined cycles are over twice those of coal plants, reflecting the higher volumes of flue gas that have to be processed to capture a tonne of CO<sub>2</sub> and the higher fuel costs.

CO<sub>2</sub> capture costs for coal-fired power plants are less sensitive to coal price, for which a relatively small range of 2020 prices is projected. The range presented in Table 8.1 therefore represents the different costs of the three capture technologies – a fairly narrow band – taking the central case estimate of coal price. The costs presented in Table 8.1 (and 8.2) are from the ‘OPTI’ case considered in the ZEP study, i.e. they are plants commissioned after the first full-sized plants have been in operation, and so incorporate technology improvements, better plant integration, lower-risk margins, etc. compared with the first commercial plants (resulting in 10–12% lower costs than those first plants). Chapter 3 has concluded that there may be only modest scope to reduce further the capture costs over the next 20 years. Although further incremental improvements may be expected beyond that timescale, improvements that are more substantial based on radically new technologies and configurations are speculative at the present time.

The figures presented are for base load operation: costs escalate sharply for part load operation, a potentially significant factor in a future EU electricity system that may require mid-load operation of many fossil plants.

There are wide ranges both in transport and storage costs in Table 8.1, reflecting the variations in geological settings

**Table 8.1 CO<sub>2</sub> avoidance costs (based on ZEP, 2011a) for application of CCS to power plants (2009 money values)**

	Hard coal power plant (€/t CO <sub>2</sub> )	Natural gas power plant (€/t CO <sub>2</sub> )
Capture	30–35	66–90
Transport		2–16
Storage		1–20
<b>Totals</b>	<b>33–71</b>	<b>69–126</b>

and locations in Europe, which to some extent translate into transport costs. Much of Europe’s anticipated storage capacity will be in saline aquifers offshore, tending to push transport and storage costs to the higher end of the ranges. As discussed in Chapter 5, there is a substantial and urgent incentive to identify and firm-up on the characteristics of the best storage sites (those with high capacity/injectivity and close to capture facilities) which will help to offset this tendency, at least for the early stages of full-scale commercial deployment of CCS. It will also enable the design of optimal transport networks, again helping to minimise costs.

It is instructive to compare the CO<sub>2</sub> avoidance costs shown in Table 8.1 with EU allowance prices projected in the range of studies reviewed in the impact assessment underpinning the EU’s Roadmap 2050 (European Commission, 2011g), which are reproduced in Figure 8.1. The vertical bars in Figure 8.1 show the EU allowance prices projected in various studies for 2020, 2030 and 2050.

For coal-fired power plants, projected EU allowance prices in 2020 are generally below the CO<sub>2</sub> avoidance costs, suggesting that additional economic or regulatory incentives would be needed to stimulate the construction of coal-fired stations with CCS. By 2030, anticipated allowance prices are sufficiently high in around half of the projections provided CO<sub>2</sub> avoidance costs are at the low end of the range given in Table 8.1. This again points to the need to identify the better storage sites (reducing storage and transport costs) to enable the early tranches of coal-fired stations with CCS to go ahead.

In 2050, the four projections reproduced in Figure 8.1 are divided: for the two lower projections, it would remain necessary for coal-fired stations with CCS to achieve CO<sub>2</sub> avoidance costs in the lower part of the range given in Table 8.1. A question therefore arises as to whether there is enough storage capacity available in Europe with the necessary favourable characteristics to achieve costs at the low end of the range, particularly if CCS is to make a major contribution to mitigating climate change. For the two higher projections, coal-fired plant with CCS is

Figure 8.1 Projected EU allowance prices in €<sub>2008</sub>/t CO<sub>2</sub> from a range of studies (European Commission, 2011g: providing details of scenarios and studies).

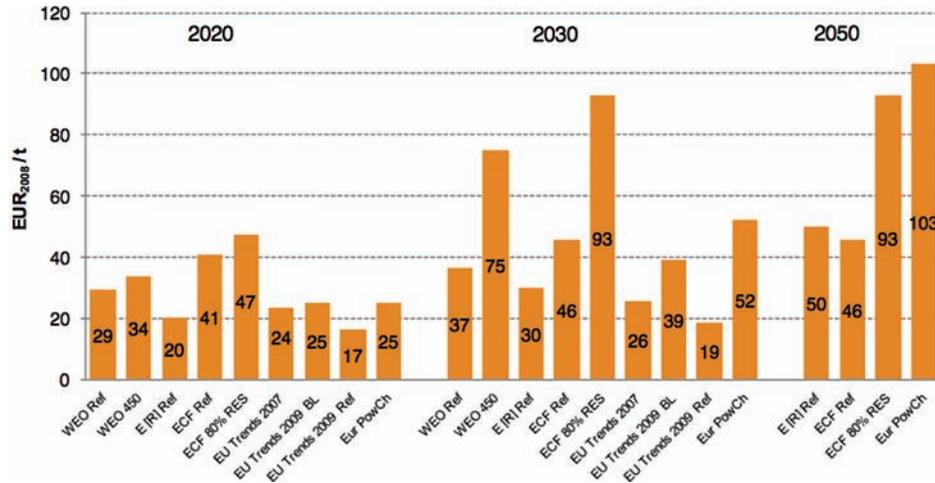

able to undercut EU allowance prices for the full range of avoidance costs given in Table 8.1. As previously discussed, although some modest reductions in capture costs over the period to 2050 owing to technology improvements are anticipated, these may be offset as storage and associated transport costs increase because of the need to make use of less favourable storage sites.

CO<sub>2</sub> avoidance costs for gas-fired combined cycles are generally higher than projected EU allowance prices except for the two higher projections in 2030 and 2050. Given the resurgence of interest in gas for power generation in Europe, this is a significant issue. The economic viability of coal- and gas-fired stations with CCS can be seen to be very sensitive to uncertainties in EU allowance prices over their lifetimes. It is noted that the impact assessment for Roadmap 2050 (European Commission, 2011g) included predicted EU allowance prices which remain at around €50/t CO<sub>2</sub> in 2050 for the reference and 'current policy initiatives' scenarios, but rise to high levels (€30–310/t CO<sub>2</sub>) in 2050 in the others considered. At these high values, all the ranges of CO<sub>2</sub> avoidance costs from both coal- and gas-fired stations with CCS are economic.

Table 8.2 illustrates the impact of CCS on the costs of generation, again based on cost data presented in ZEP (2011a). For coal-fired power plants, the ranges of transport and storage costs considered as plausible in a European context in the ZEP report have a big impact on generating costs, pushing the cost increase over equivalent stations without CCS to a range of 42–117%.

The generating costs of gas-fired combined cycle plants with CCS are less sensitive to transport and storage costs as there is significantly less CO<sub>2</sub> produced per megawatt hour of power. They are, though, sensitive to gas costs, which remain very uncertain in the future.

To compare the generating costs of coal- and gas-fired power stations incorporating CCS with other low carbon

Table 8.2 Generating costs (based on ZEP, 2011a) (2009 money values)

	Hard coal power plant (€/MWh)	Natural gas power plant (€/MWh)
Capture	65–70	64–115
Transport	2–15	0.6–6
Storage	1–19	0.4–8
<b>Totals</b>	<b>68–104</b>	<b>65–129</b>
Without CCS	48	45–90
Increase due to CCS (%)	42–117	~43

From ZEP (2011a):

- Capture – hard coal: range reflects three capture technologies for OPTI option (i.e. 'second phase' commercial plants), base load operation and €2.4/GJ coal price.
- Capture – natural gas: range reflects variation in gas price €4.5–11.0/GJ (a key sensitivity/uncertainty) with reference gas combined cycle plus PCC, base load operation.
- Transport: shows a range of transport costs for 20 Mt per annum networks for onshore and offshore storage, and distances of 180–1500 km (as presented in Chapter 4).
- Storage: shows range from onshore disused oil and gas fields to offshore saline aquifers (as presented in Chapter 5).
- Totals: sums of low and high points on ranges.

technologies, cost estimates need to be prepared on a consistent basis. Such an exercise has been conducted by the Global CCS Institute (2011c), which has taken six recent comparative studies and adjusted costs according to a consistent set of assumptions. The results (translated into 2010 euros) are summarised in Table 8.3, which presents the ranges of current costs per MWh and per tonne of CO<sub>2</sub> avoided, after adjustments to enable consistent comparison, from the six studies.

The costs of coal- and gas-fired stations with CCS fall in the middle of the range of current costs of the technologies considered. They are more expensive than geothermal, hydropower, onshore wind, nuclear and biomass,

**Table 8.3 Comparison of costs of fossil-fired power generation with CCS with other low-carbon technologies. Source: Global CCS Institute, 2011c**

Technology	Levelised cost (€/MWh)	Levelised cost (€/t CO <sub>2</sub> )
Geothermal	32–46	–29–0
Hydropower	39–45	–20–0
Wind onshore	51–65	–6–15
Nuclear	51–71	–5–19
Biomass	61–85	7–37
<b>CCS (coal)</b>	<b>67–105</b>	<b>22–69</b>
<b>CCS (natural gas)</b>	<b>81–90</b>	<b>51–80</b>
Wind offshore	110–162	68–133
Solar thermal	140–200	138–153
Solar photovoltaics	166–200	137–180
Reference coal plant no CCS	55	
Reference gas plant no CCS	65	

€/£ conversion = 0.755; 2010 money values.

but cheaper than the current costs of offshore wind, concentrating solar power (CSP) and solar photovoltaics.

Care must be taken not to over-interpret a comparison based on levelised costs of electricity, as the relative economics of alternatives will be determined by the value of the electricity generated (which can only be evaluated at the overall system level of the electricity system that the plant contributes to). Key factors in determining the value of electricity generated will be the timing of when it is generated and the ability of the plant to support system operation (matching supply and demand): its dispatchability.

Provided adding CCS to a coal- or gas-fired station does not compromise its dispatchability, its generation can be worth more than that from a variable renewable energy source such as wind or solar photovoltaics. This emphasises the importance of minimising the constraints that adding a capture plant place on the station's ability to vary load, and of demonstrating that coal- and gas-fired plants with CCS can meet the requirements of the electricity system operator to vary load. However, as noted above, mid-load operation of coal- and gas-fired plants with CCS adds substantially to the costs of generation and CO<sub>2</sub> avoidance. This potential dispatchability (and hence value) advantage does not apply to the comparison with CSP, which can meet system dispatchability requirements if thermal storage is incorporated (EASAC, 2011). The same is true of hydropower and generation from geothermal sources.

It is also important to consider future costs, not just those that apply at present. Wind and solar technologies have

demonstrated steep learning curves, and, being still relatively young technologies, are anticipated to continue to reduce rapidly in cost. For example, the EASAC report on CSP (EASAC, 2011) projected that CSP is likely to be cost competitive with fossil-fired plants with CCS (and to have broadly equivalent dispatchability characteristics) at some point in the decade 2020–2030, i.e. just when the commercial roll-out of CCS is anticipated. Similarly, McKinsey and Company (2010) project that CCS will be the highest cost technologies in 2030 in the broad range of options for greenhouse gas abatement that they considered.

In contrast, the capture component of CCS, which accounts for the main part of the cost, comprises largely mature technologies: a point frequently made by advocates of the early deployment of CCS. It has been concluded in Chapter 3 that there is consequently rather limited scope to squeeze cost savings from capture, unless more radical new technologies come to commercial fruition towards 2050, which are currently not foreseeable. Storage costs, and hence transport costs, depend on the location of the storage facility and its characteristics. As discussed, within the constraints of issues such as public acceptance, it may be necessary to use the cheaper storage sites first, so storage and transport costs may in fact increase over time, rather than decrease. Learning rates for site characterisation, which might reduce costs over time, are likely to be slow given the long timescales over which the performance of a storage facility can be evaluated.

## 8.2 Factors influencing future prospects

Many factors will influence the scale of CCS deployment in Europe over the four decades to 2050, and beyond. The following paragraphs focus on five of them:

- financial viability;
- storage issues;
- the technology;
- CO<sub>2</sub> transport infrastructure; and
- public perception.

A first challenge for the **financial viability** of CCS is to secure funding of the demonstration projects, an essential first step towards enabling CCS to contribute to climate change mitigation in Europe. As discussed in Chapter 2, the view developing in 2012 was that financial constraints point to three or four demonstration projects being a more realistic target, rather than the 12 originally envisaged. Although this may be a pragmatic revision in the present circumstances, it means that the foundation for subsequent commercial roll-out of CCS will be less

secure than had previously been considered necessary. Given the delays to the demonstration plants, it will also be established later than had been anticipated.

Looking beyond the demonstration plants to the early commercial plants, the analysis presented in the previous section indicates that for coal-fired stations projected EU allowance prices under the ETS in the 2020s are unlikely to be a sufficient incentive except in particular circumstances, where other financial factors such as the value from enhanced oil recovery and/or exceptionally good storage opportunities enable a financially viable scheme to be established. An early priority will be to identify, and to start to develop, these niche opportunities. Application of CCS to gas-fired stations is likely to remain uneconomical in the 2020s if it just relies on EU allowances prices.

Appropriate frameworks for sharing the risks of first-generation commercial plants will need to be developed, with governments taking an appropriate role, as it will not be possible to provide the normal commercial guarantees associated with mature plants on operating characteristics such as efficiency, reliability, emissions and load following (Wall, 2011). For medium-sized companies, involvement in a first-generation commercial CCS power plant may involve 'betting the company' given the scale of the costs and inherent uncertainties: risk mitigation frameworks need to be developed so that such companies can take an active role in pushing CCS forward.

Early phase commercial deployment in the 2020s may therefore need a further 'boost' in addition to EU allowances. This might take the form of feed-in tariffs or 'contracts for difference' as have been introduced in the UK (DECC, 2012), or some form of regulatory requirement (for example an emission limit). It is important that there are good prospects for commercial application of CCS in the 2020s so that power plant manufacturers have the incentive to get behind the technology to push forward its development and improvement, and to build the experience that will provide the 'second layer' of the foundations for a more substantial deployment of CCS beyond 2030 as anticipated in the Commission's modelling studies discussed in Chapter 2. That experience is needed to build confidence that the cost and performance estimates currently being made in engineering studies are realistic: the technologies in competition with CCS to deliver a low carbon electricity system will have established a substantial track record of commercial application, and hence a firm cost basis, by the 2020s.

The take-off in CCS in the 2030s projected in the Roadmap 2050 modelling studies is illustrated in Figure 2.1 in Chapter 2. The analysis presented in the previous section suggests that coal-fired stations with CCS will need to achieve costs at the lower end of the predicted ranges to support this take-up if just relying on EU

allowance prices, and that if gas-fired stations with CCS are to be part of the post-2030 CCS mix then some additional financial or regulatory incentive is likely to be required. The volatility and predicted wide ranges of EU allowance prices are likely to act as a further disincentive to investments in CCS in a risk-averse power sector.

Post-2030, renewable energy sources with very large potential capacity such as solar (photovoltaics and CSP) and possibly offshore wind may offer generating costs on a par with fossil-fired plants with CCS. Provided that addition of CCS to coal- and gas-fired stations does not compromise their ability to change load at rates required by the grid operator (which remains to be demonstrated), the value of electricity generated by fossil-fired stations with CCS may, depending on the system, be higher than that from variable renewable energy sources such as wind and solar photovoltaics (but not from CSP with storage, hydropower and geothermal). However, as previously discussed, the costs of CO<sub>2</sub> avoidance for fossil-fired stations with CCS increases significantly for mid-load operation compared with base-load, and they remain vulnerable to escalating fossil fuel prices (probably more of an issue for gas than coal) whereas renewable energy sources do not. So, achieving CO<sub>2</sub> avoidance costs that are lower than EU allowance prices is not enough: the preferred generating mix will depend on the relative costs and values of other options, which can only be evaluated at the system level. More system simulation studies of Europe's electricity system are needed, including the use of high-resolution and stochastic power system models, to explore the sensitivities and to establish a better understanding of the key factors determining preferred outcomes in different scenarios.

In evaluating the relative merits of fossil-fired stations with CCS and renewable energy sources, consideration needs to be given to their emissions of greenhouse gases. Although they all achieve much lower levels than unabated fossil-fired plants, residual emissions from coal-fired stations with CCS (typically achieving CO<sub>2</sub> retention rates of, at best, around 90% when both direct and indirect emissions are taken into account) are significantly higher than those from renewable energy sources (typically arising from the CO<sub>2</sub> embodied in construction). This difference could be significant in the context of an electricity system in Europe, where the EU's goal is to achieve near-zero greenhouse gas emissions by 2050. Gas-fired power stations with pre-combustion or oxy-combustion CCS may be able to do better, which is helpful in the context of increasing European interest in the use of gas for power generation, provided the cost issues discussed previously can be overcome.

Many of the CCS technologies presented in Chapter 3 can be applied in other industries as well, not only in the power sector. Although CCS is seen as a bridging technology in the power sector in the long term, the situation is more difficult for other industries, such as steel

and cement production. For instance, coal is required for producing steel, and calcium carbonate for producing cement, which results inevitably in CO<sub>2</sub> emissions. In addition, steel is a global market, whereas the electricity market is regional. Future high EU allowance prices would make it difficult for the European steel industry to be competitive in a global market. Similarly, the additional costs for CCS would make it difficult for European industries with high CO<sub>2</sub> emissions to remain competitive in a global market, unless similar CO<sub>2</sub> trading schemes (or CO<sub>2</sub> taxes) were used outside Europe. This is likely to require a global, binding agreement on the reduction of greenhouse gas emissions.

A similar story can be told for Europe's chemical industry. However, the growing R&D investments in the conversion of CO<sub>2</sub> in base chemicals and biomass are embedded in a long-term vision of the chemical industry to reduce its dependency on oil and gas and to close the industrial carbon cycle in the long term (Cefic, 2011).

With regard to **storage**, estimated capacity is sufficient overall to meet Europe's anticipated needs to 2050 and beyond. However, these estimates are very uncertain and an early priority should be to develop a firmer picture of the location, capacity and characteristics of Europe's potential CO<sub>2</sub> storage sites. This is necessary to inform the development of the CO<sub>2</sub> transport network as discussed below, and to develop a better understanding of the cost profile of Europe's storage capacity.

The capacity that can eventually be used will depend not only on the geological characteristics of potential storage sites, but also on issues of public acceptance. As discussed in Chapter 7, at present it is proving difficult in some communities to gain public acceptance for onshore storage. If this situation continues, a substantial part of Europe's storage capacity will be ruled out. This part is also the cheaper capacity, and so storage and transport costs would be significantly higher than they would otherwise.

For CO<sub>2</sub> capture, substantial increases in understanding of actual costs and performance can be achieved on timescales of months and (relatively few) years as demonstration and commercial plants are built and operated. For storage, such understanding can only be built more slowly, with some elements only emerging on timescales of decades given the need to monitor the relevant geological processes. This reduces the potential to benefit from learning-curve effects in bringing down the costs of storage site characterisation and monitoring, given anticipated ramp-up rates of CCS projected in European Commission studies.

More significantly, it impacts on the rate at which confidence in the permanence and long-term safety of the storage can be built with regulators and the public, as substantial quantities of CO<sub>2</sub> accumulate underground. As storage facilities are expected to operate for 30–40

years, this could lead to the uncomfortable situation in 2050 that a large inventory of CO<sub>2</sub> has been stored underground without any facility having completed regulatory sign-off. A partial answer to this dilemma may be to 'fast-track' one or more storage facilities through the regulatory process, so that generic issues can be exposed and hopefully resolved. In this regard, the EU-funded FP7 SiteChar project (<http://www.sitechar-co2.eu/>) is currently conducting dry-run licensing processes applied to a range of settings.

To establish that the costs and performance of **CCS technologies** meet expectations, the planned demonstration plants are a crucial next step. For capture, a key issue will be to demonstrate that the responsiveness and dispatchability of power stations is not significantly compromised. Looking to second- and third-generation CCS installations, research, development and demonstration of the advanced technologies discussed in Chapter 3 will be key to improving the economics of CCS, although with modest expectations of the reductions in cost that may eventually be achieved.

As discussed in Chapter 4, 5–10 years of research, development and demonstration may be required to reach the necessary levels of confidence for large-scale deployment of CO<sub>2</sub> pipelines in Europe. For ship transport, scale-up to commercial capacities needs to be demonstrated on similar timescales. The challenges for storage have been discussed above: they will be more significant for saline aquifers (where the major part of Europe's storage capacity is expected to lie) than for mature and depleted oil and gas fields.

A generic challenge for CCS is that it requires the integration of four very different industries: gas and chemical processing, power generation, transport networks, and geological storage. Each of these has, or has to develop, its own cultures and levels of risk and returns, and each relies on different capital providers. Concerns have been expressed that the likely pace of development of CCS technology has been overestimated (Hansson, 2012), consistent with more general findings that experts tend to be over-optimistic about the future of technologies they are involved in developing (see, for example, Tichy, 2004).

As discussed in Chapter 4, a strategic approach to developing an integrated **CO<sub>2</sub> transport** network for Europe as a whole will lead to a substantially cheaper outcome requiring less transport corridors (and hence planning permissions that are potentially difficult to acquire) than if a piecemeal approach is taken. A necessary precursor is a much better fix on the locations of Europe's storage capacity. Annex 3 describes a potential regional approach enabling the strategic integration of sources, storage sites and CO<sub>2</sub> transport networks, and founded on an iterative identification and characterisation of storage capacity.

A significant challenge will be to put in place financing mechanisms that will enable this transport infrastructure to be developed, particularly to address the issue that pipelines will initially need to be over-sized to allow for the progressive linking-in of sources and storage facilities.

It is encouraging that the development of a cross-border network for CO<sub>2</sub> transport has been included in the Commission's 2011 proposal for the regulation and support of critical trans-European energy infrastructure (European Commission, 2011h), which seeks to streamline permit-granting procedures and to provide the necessary market-based and direct EU financial support to enable implementation of projects of common interest. However, experience in Europe so far is that the period experienced by major infrastructure projects for planning and gaining consent regularly exceeds 10 years. It remains to be seen whether the Commission's initiatives can make significant inroads on such timescales, particularly given concerns discussed next that associated public engagement processes should not be rushed. If not, the development of the CO<sub>2</sub> transport infrastructure may prove to be a significant constraint on CCS deployment.

Issues of **public perception** may yet prove to be the main determinant of the contribution of CCS in Europe. The picture across Europe is heterogeneous: public acceptance is not yet emerging as a major issue in countries such as Norway and the UK (which are focusing on offshore storage), but public and political opposition are seemingly hardening in countries such as Germany and the Netherlands. This heterogeneity will act as a constraint on the contribution of CCS, not only because of the lack of take up of CCS in some countries, but also because the scope for an integrated European CCS infrastructure may consequently be limited.

In planning for CCS in Europe, sufficient time needs to be allowed for the public debates at EU and national levels, which will enable publics to decide, through appropriate political processes, on the role that CCS should play in national strategies to mitigate climate change. And sufficient time needs to be built into project schedules at a local level for meaningful public engagement to achieve the 'licence to operate' arising from stakeholder acceptance. These processes of public engagement will act as a constraint on the pace at which CCS can progress in Europe, and in some cases, for example the development of the CO<sub>2</sub> transport network, may be the rate-limiting consideration.

A major uncertainty in the outlook on public perception is the potential for future accidents or major problems

at ongoing CCS projects. The example of the nuclear industry shows that accidents in one location (i.e., Fukushima) can be game changers for countries far away (e.g., Germany and Switzerland). It is possible that public perception on CCS could be dominated by a single future accident, such as a major release of CO<sub>2</sub> or damage through induced seismicity.

A key concern is the limited progress that has been made so far in gaining public support for onshore storage facilities. As discussed in Chapter 7, an overall roll-out strategy in Europe may, of necessity, initially prioritise offshore locations and sites that already host relevant industrial activities, which may be more receptive to CCS. If a track record of success can be built in these locations, roll-out to others may follow in due course. However, this strategy will tend to increase the costs of CCS in the early commercial phases when anticipated, modest, EU allowance prices will in any case challenge the financial viability of CCS. And if public acceptance of onshore storage is not secured in the long term, costs will remain higher than they would have been otherwise, and overall capacity will be more limited.

### 8.3 Prospects to 2050

The previous section has pointed to a complex interaction of factors that will influence the eventual outcome in respect of the contribution that CCS will make in Europe on timescales to 2050. It would therefore be inappropriate to identify a particular outcome in terms of the amount of CO<sub>2</sub> that will be captured and stored through CCS technologies. However, a picture does emerge of delays in, and downsizing of, the first steps, in particular the proposed set of demonstration plants, of continuing challenges to the economic viability of CCS, and of difficulties of public acceptance, which may constrain the possible locations and rates of development of transport and storage infrastructures. Confidence in the safety and permanence of CO<sub>2</sub> storage will build relatively slowly and will largely depend on the track record of successful large-scale projects.

Given this picture, an outcome in the lower end of the range<sup>5</sup> explored by the European Commission (as reviewed in Chapter 2) may be a more realistic central case. The core of this contribution would lie in CCS applications with favourable juxtapositions of sources, sinks and public acceptance, and from an electricity systems point of view, enabling fossil-fired power stations to play a key role in balancing supply and demand in an electricity system having close-to-zero greenhouse gas emissions and relying primarily on renewable energy sources. Moreover, CCS could help reduce the CO<sub>2</sub> footprint of key industrial sectors such as steelmaking and cement production, and it may help Europe's chemical and gas industry to make the shift towards zero-emission

---

<sup>5</sup> The modelling scenarios undertaken for Energy Roadmap 2050 projected shares of EU power generation for fossil-fired stations with CCS in the range 7–32% (European Commission, 2013).

production processes. Positioning CCS in this way may help to overcome opposition founded on a belief that pursuit of CCS will be at the expense of developing renewable sources.

This will still mean that CCS plays an important part in Europe's activities to mitigate climate change over the next 40 years, and will still require a sustained political will, backed up by concrete policy interventions, if it is to happen. Otherwise, the 'window of opportunity' for CCS, envisaged as a bridging technology en route to an energy economy founded primarily on sustainable energy sources, will close. And Europe's 2050 greenhouse gas reduction targets will be significantly more difficult to achieve. It also means that Europe should not relax its efforts to develop and deploy sustainable energy

sources, and to ensure that they can deliver the required performance at an acceptable cost.

The consideration of alternatives to 'mainstream' CCS in Chapter 6 has identified certain promising niche applications, such as biomass CCS, waste carbonation, biochar and CO<sub>2</sub> use, but concluded that they are unlikely to make a substantial contribution to reducing emissions of CO<sub>2</sub>. In the long term, processes such as mineral carbonation, which are currently at the experimental stage, have potentially attractive characteristics in terms of capacity and permanence, and may be able to play a significant role. However, substantial improvements over current indications of performance will be needed, particularly in costs and energy requirements.



## 9 Conclusions

This report has considered the three main components of CCS – capture, transport and storage – and has presented an evaluation of alternatives to mainstream CCS technologies together with a review of the important, overarching issue of public engagement. Drawing these strands together, it has evaluated the prospects for CCS in Europe up to 2050, and (in the Chapter 10) makes recommendations on the policy initiatives considered necessary to enable CCS to contribute appropriately in Europe to climate change mitigation. This Chapter draws together the main conclusions on capture, transport, storage, alternative approaches, public engagement and prospects to 2050.

### 9.1 CO<sub>2</sub> capture

The three main technologies for CO<sub>2</sub> **capture** are concluded to have different strengths and weaknesses, and at this point for power generation applications are anticipated to have broadly similar CO<sub>2</sub> capture and generating costs. A choice between them will depend on the specific parameters of the application. All are considered technologically feasible, but integrated operation at commercial scale remains to be demonstrated. CO<sub>2</sub> capture currently adds around 50% to the levelised cost of electricity. For all three technologies there are many developments in train in Europe and elsewhere that are intended to reduce this cost penalty, and which may bring it down to 30–45% over the next 20 years. Further incremental improvements are expected beyond that timescale. More substantial improvements based on radically new technologies and configurations are speculative at the present time.

For other industries, the capture technologies are being adapted for application to cement and steel manufacture, and pre-combustion capture technologies are already being applied in the chemical and petrochemical industries. Whereas CCS may be seen as a bridging technology as power generation moves away from dependence on fossil fuels, for the cement, steel and petrochemical industries CO<sub>2</sub> generation is an inherent feature of current processes, so CCS is not just an interim solution. A key consideration for European policy is that a requirement to install CCS on such industrial facilities does not just drive them to other parts of the world where regulation is less restrictive.

### 9.2 CO<sub>2</sub> transport

**Transport** of CO<sub>2</sub> may be by pipelines or ships, the latter potentially being favoured for small and/or remote offshore locations or where flexibility is required, particularly in start-up phases. For ship transport, scale-up to commercial capacities in the context of CCS needs

to be demonstrated, and for pipelines further research, development and demonstration work is needed to enable their economic and safe design and operation in light of anticipated impurities and operational regimes in Europe. Although it may confidently be anticipated that this work will lead to a successful outcome, 5–10 years may be required to reach the necessary levels of confidence to underpin large-scale deployment of CO<sub>2</sub> pipelines in Europe.

The CO<sub>2</sub> transport network will sit alongside the gas pipeline and electricity transmission networks as a key component of Europe's energy infrastructure. Initiatives to be taken in relation to the EU energy strategy to streamline permitting procedures and to improve public engagement processes for projects of European interest are of crucial importance to CCS. The development and operation of an integrated, cross-border CO<sub>2</sub> transport infrastructure in Europe, linking large networks of capture and storage sites, represents a major logistical challenge.

### 9.3 CO<sub>2</sub> storage

The processes of CO<sub>2</sub> **storage** are broadly understood, but significant uncertainties remain which will need to be addressed to provide sufficient confidence to regulators and the public that CO<sub>2</sub> storage will be safe over the long term. In Europe, the planned demonstration plants will be a key enabler of the required learning process and should be set up to maximise the useful information that can be generated. Pilot-scale injection tests, large-scale laboratory experiments and model validation initiatives will also play an important role in building understanding, in some cases on shorter timescales than the demonstration plants. Also, much can be learned from developments outside Europe, for example in North America, Australia and China, which in turn can benefit from the European experience from a two-way exchange of information.

The precise levels of confidence that will eventually be required in respect of the various issues impacting on the long-term safety of CO<sub>2</sub> storage, and the consequent degree of resolution of these uncertainties that will be expected, will emerge from an iterative process of confidence building between developers and regulators, in which publics should play an active part. Acceptable levels of confidence and resolution of uncertainties will be influenced by the urgency of action to mitigate climate change on the one hand, and by liability issues, public concerns, and the long periods over which CO<sub>2</sub> must be safely stored on the other.

The rate at which uncertainties can be resolved, and knowledge gained, will be constrained by the need to observe geological processes, some over periods

of years to build sufficient understanding, but others (for example CO<sub>2</sub> migration and retention processes, and borehole seal integrity) potentially over decades. Similarly, characterisation of a candidate storage site to achieve sufficient confidence to commit to CO<sub>2</sub> injection may take several years, and generally more for saline aquifers where the major part of estimates storage capacity rests than for depleted oil and gas fields given their previous characterisation. These factors will be an important influence on the rate at which CCS can be deployed in Europe.

Estimates of the location and characteristics of Europe's storage capacity are uncertain, but identify saline aquifers as constituting the major part (around 80%) of the capacity. Relatively few large fields make up a large part of this capacity and should be an early target for better characterisation. This is particularly so, as estimated costs of CO<sub>2</sub> storage cover a wide range (significant in respect of the anticipated breakeven costs of CCS) according to the location, capacity and characteristics of storage sites. Low-cost sites, typically large reservoirs with good injectivity, will be at a premium, particularly in the early phases of CCS roll-out. Although learning-curve effects may lead to some reduction in characterisation and operation costs over time, the more dominant effect may be the need to make use of progressively more expensive storage sites as the cheaper ones will have been used in earlier phases of CCS deployment.

## 9.4 Alternative approaches

In the near future, there seem to be no feasible (in technical, economic or environmental respects) **alternative approaches** to CO<sub>2</sub> capture and geological storage capable of making a major contribution to climate change mitigation, although there are several interesting concepts being developed that could provide some modest additional means for reducing greenhouse gas emissions in the future. Carbonation of rocks would provide the ideal means for CO<sub>2</sub> storage, but no practicable process concept has been found yet.

The technologies for biochar, use of biomass with CCS, waste carbonation, algae cultivation and CO<sub>2</sub> use in chemical processes have already reached the pilot and demonstration stage. These methods are applicable only if certain conditions are met and, therefore, their potential for greenhouse gas emission reduction is restricted. Although these methods are important concepts for sustainable development, none are comparable in terms of CO<sub>2</sub> abatement capacity to geological storage in association with capture of CO<sub>2</sub> from fossil-fired plants.

## 9.5 Public engagement

For **public engagement**, more concerted initiatives are needed at the EU, national and local levels to debate the

value of CCS in the context of climate change mitigation strategies, and consequently to build awareness and acceptance of the potential of CCS as an option for climate change mitigation. Such initiatives may appropriately be taken in parallel with the demonstration projects currently being developed, which should help to ground the debate and to build familiarity over time with what CCS constitutes in practice. Looking beyond the demonstration plants, there is a case that the social setting for CO<sub>2</sub> storage facilities should be given greater weight, alongside the suitability of the geological setting and location in relation to capture sites, in deciding where to locate CO<sub>2</sub> storage facilities.

Public engagement at national and EU levels to establish the social context for CCS, and at local levels in respect of individual facilities, needs to be given sufficient time and should have substance in the sense of allowing 'no' as the answer either nationally or locally. This will impact on the rate at which CCS can be deployed in Europe and is likely to reduce the storage capacity onshore: but the significance of that impact cannot currently be estimated. By ramping up engagement activities sooner rather than later, an earlier understanding can be established of the extent to which issues of public acceptance will prove to be a key determinant of CCS's contribution to mitigating climate change in Europe. The EU demonstration projects should play an important role in respect of building public familiarity with, and understanding of, CCS.

## 9.6 Prospects for CCS in Europe up to 2050

The key factors influencing the **prospects for CCS in Europe up to 2050** have been identified as financial viability, storage issues, technology development needs, CO<sub>2</sub> transport infrastructure and public acceptance, conclusions on which have been summarised in the preceding paragraphs. A complex interaction of these factors will influence the contribution that CCS will make, and it would therefore be inappropriate to identify a particular outcome in terms of the amount of CO<sub>2</sub> that will be captured and stored in Europe through CCS technologies. However, a picture does emerge of delays in, and downsizing of, the first steps (in particular the proposed set of demonstration plants), of continuing challenges to the economic viability of CCS, and of difficulties of public acceptance which may constrain the possible locations and rates of development of transport and storage infrastructures. Confidence in the safety and permanence of CO<sub>2</sub> storage will build relatively slowly.

Given this picture, an outcome at the lower end of the range (7–32%) for the contribution of fossil-fired power stations with CCS to EU power generation explored by the European Commission, as discussed in Chapter 2, may be a more realistic central case. The core of this contribution would lie in CCS applications with favourable juxtapositions of sources, sinks and public

acceptance. From an electricity systems point of view, it would focus on situations where CCS enables fossil-fired power stations to play a key role in balancing supply and demand in an electricity system having close-to-zero greenhouse gas emissions relying primarily on renewable energy sources, and possibly nuclear power. Moreover, CCS could help reduce the CO<sub>2</sub> footprint of key industrial sectors such as steelmaking and cement production, and it may help Europe's chemical and gas industry to make the shift towards zero-emission production processes. Positioning CCS in this way may help to overcome opposition founded on a belief that pursuit of CCS will be at the expense of developing renewable sources.

At present, the financial and policy conditions are not in place to attract private investment in CCS. Initial

enthusiasm for CCS appears to be waning under the harsh spotlight of funding demonstration plants and the first-generation commercial facilities that should follow. Unless decisive policy actions are taken to address this issue, and to provide investors with sufficient confidence in returns over the lifetime of projects, particularly bearing in mind large potential liabilities, this situation looks set to continue. If CCS is to make a significant contribution in Europe to climate change mitigation, technologies, capacity and infrastructure need to be developed steadily and with greater urgency than currently prevails. CCS is not a tap that can simply be turned on, if and when suitable financial conditions emerge or future policy makers decide that CCS is a crucial component of Europe's energy strategy.



## 10 Recommendations

Recommended actions and policy initiatives to enable CCS to realise its contribution in Europe over the period to 2050 are identified in this chapter, using the same five headings (financial viability, storage issues, the technology, CO<sub>2</sub> transport infrastructure and public perception) as Chapter 8.

### 10.1 Financial viability

- Current problems of securing sufficient funding for the demonstration projects may, in the short term, appropriately be addressed by focusing the available public funds on fewer (three or four, not fewer) demonstration projects rather than to attempt to fund up to 12 projects as originally planned. However, it has previously been concluded (ZEP, 2008) that a minimum of six or seven demonstration projects are needed to demonstrate an adequate range of technologies and application options (including to industrial processes), so a second tranche of demonstration projects will need to be planned for and financed. To secure the financial viability of the projects, attention needs to be paid to their operational costs as well as to their capital costs, and appropriate subsidies should be developed as necessary if the price of EU allowances in the EU ETS are inadequate. Current rules for funding the demonstration projects may need to be revisited to enable funding packages to be created which will enable commercially viable projects to be established in the current, difficult circumstances.
- Sole reliance on the price of EU allowances in the EU ETS to drive CCS in the early commercial phases may prove to be insufficient for coal-fired stations, except possibly in a limited number of cases where costs are particularly favourable and/or there is an additional source of revenue, for example from enhanced oil recovery. It will almost certainly not be sufficient for gas-fired stations. Commercial aversion to the risks arising from volatile and difficult to predict prices of EU allowances will further exacerbate these difficulties. To avoid the risk that rather few power stations with CCS will be built in the two decades after the demonstration plants, consideration should be given to additional funding mechanisms such as feed-in tariffs or 'contracts for difference' to tip the economics in favour of CCS deployment, and to the appropriate division of risks between governments and commercial developers.
- Currently, only geological storage in association with CO<sub>2</sub> capture from fossil-fired plants is included as a viable option for reduction of CO<sub>2</sub> emissions in the EU trading scheme. Therefore, there are no

economic drivers for further developing alternative technologies such as the use of biomass with CCS, waste carbonation, biochar and CO<sub>2</sub> use. Although the CO<sub>2</sub> mitigation capacities for these options are at best modest, they are important technologies from the viewpoint of sustainability and can have a significant local CO<sub>2</sub> emission reduction capacity. Although the EU allowances price is currently low, it is expected to rise in the future and would therefore be an important driver for developing these options into commercial processes. Thus, these options could be included in the EU ETS, under the condition that the mitigation effect from the life cycle of these options (especially in the case of CO<sub>2</sub> use) is significant, and can be measured and proven.

- Care must be taken in pushing forward CCS that carbon-intensive industries are not driven to other regions where there are fewer restrictions: 'carbon leakage'. Well-designed packages of regulatory and financial measures will be needed to avoid this problem, and will need to be kept under review in light of progress elsewhere in the world. The EU should continue to influence developments globally to secure the introduction of similar levels of environmental protection elsewhere, not least because the EU currently represents only around 11% of global greenhouse gas emissions (European Commission, 2013b).

### 10.2 Storage issues

- An early strategic investment should be made to locate and characterise Europe's CO<sub>2</sub> storage capacity, so that a significantly more confident picture is developed than is available now. This may require a substantial investment (comparable to the cost of a demonstration plant), but will provide good value in enabling an integrated approach to the development of Europe's CCS infrastructure. The picture should continue to be updated as new characterisation initiatives are taken in individual countries.
- A strong focus should be placed on activities to accelerate confidence building on the permanence and safety of CO<sub>2</sub> storage: key priorities have been described in Chapter 5 in respect of storage capacity, site integrity, monitoring, and model development and validation. This should include fast-tracking several storage facilities through the complete regulatory process to minimise associated uncertainties as the volumes of stored CO<sub>2</sub> accumulate. The required further clarification and elaboration of regulatory frameworks should be led by regulatory bodies in collaboration with developers

and other stakeholders, and in association with the confidence-building activities referred to in the previous bullet point. Key considerations for refining regulatory frameworks have been identified in section 5.4.

- The demonstration plants are essential to provide data at large scale and should be developed as soon as possible. They can usefully be complemented by more pilot-scale injection test sites, perhaps five or six in total, similar to those at Ketzin in Germany and Lacq in France, which may be able to be implemented and deliver useful results on shorter timescales. Such pilots should appropriately receive EU financial support.

### 10.3 The technology

- Many of the R&D needs identified in Chapters 3–5 for capture, transport and storage are appropriately funded at an EU level, for example through the framework programmes for research and innovation, and through mechanisms that ensure results are made publically available subject to not compromising commercial incentives.
- Research, development and demonstration need to be tied closely to commercial application to achieve focus and sustain momentum.
- Demonstration plants should be set up to have sufficient flexibility to test a range of options, such as a set of variations of the process configuration, and different amine absorbents for post-combustion CO<sub>2</sub> capture. This should be a requirement of public funding schemes.
- Europe must also ensure that it learns from initiatives in other continents through establishing effective two-way exchanges of experience and information.

### 10.4 CO<sub>2</sub> transport infrastructure

- An integrated and strategic approach should be taken to developing Europe's CO<sub>2</sub> transport infrastructure, both pipelines and ships, which should be on a par with critical developments in

Europe's electricity grid and natural gas pipeline networks in respect of policy attention and enabling mechanisms. A pan-European perspective will be needed, addressing legislative issues as necessary to ensure that integration across borders is achieved. Better characterisation of Europe's storage capacity is a necessary precursor, as discussed above.

- There is a case for separating the ownership and operation of the transport and storage infrastructure (potentially through establishing regional owner–operators) from that of capture facilities. EU and national level funding may be needed to facilitate the development of strategic CO<sub>2</sub> transport networks, involving an appropriate balance of state and private sector funding.
- Recognising the importance of integrated CO<sub>2</sub> transport networks, the demonstration plants should include at least one that includes two sources feeding into one storage facility so that operational characteristics can be investigated.
- Ship transport of CO<sub>2</sub> needs to be fully incorporated into the provisions of the CCS Directive.

### 10.5 Public perception

- An enhanced emphasis should be placed on public debates about the role of CCS in mitigating climate change at an EU, national and local levels in relation to other options in order to increase awareness and to put decisions to proceed with CCS on a firmer footing. These debates should enable a better understanding to be developed of publics' attitudes to CCS and why they are formed.
- Consideration should be given to the potential enhancement of public understanding and acceptance of CCS by including CCS applied to biomass-based plants for generating heat and power in the overall mix of technologies comprising the CCS portfolio.
- The operation of pilot and demonstration plants should be transparent, ensuring effective channels of communication with interested stakeholders.

## References

- Abraham B (1982). *Coal-oxygen process provides CO<sub>2</sub> for enhanced recovery*. *Oil & Gas Journal* **80** (11), 68–70
- Adams E & Caldeira K (2008). *Ocean Storage of CO<sub>2</sub>*. *Elements* **4** (5), 319–324
- Adanez J, Abad A, Garcia-Labiano F, Gayan P & de Diego L (2012). *Progress in chemical-looping combustion and reforming technologies*. *Progress in Energy and Combustion Science* **38** (2), 215–282
- Alstom SA (2011). *Cost assessment of fossil power plants equipped with CCS under typical scenarios*. Alstom Power. <http://www.zeroemissionsplatform.eu/extranet-library/publication/181-cost-assessment-of-fossil-power-plants-equipped-with-ccs-under-typical-scenarios.html>
- Anderson R, MacAdam S, Viteri F, Davies D, Downs J & Paliszewski A (2008). *Adapting gas turbines to zero emission oxy-fuel power plants*. Proceedings of the ASME Turbo Expo 2008, Berlin, Germany. [http://diogenesinstitute.org/images/2/29/Adapting\\_Gas\\_Turbines\\_to\\_Zero\\_Emission\\_Oxy\\_Final.pdf](http://diogenesinstitute.org/images/2/29/Adapting_Gas_Turbines_to_Zero_Emission_Oxy_Final.pdf)
- APS (2011). *Direct air capture of CO<sub>2</sub> with chemicals - a technology assessment for the APS panel on public affairs*. American Physical Society. <http://www.aps.org/policy/reports/assessments/upload/dac2011.pdf>
- Aradóttir E, Sonnenthal E, Björnsson G & Jónsson, H (2012). *Multidimensional reactive transport modeling of CO<sub>2</sub> mineral sequestration in basalts at the Hellisheidi geothermal field, Iceland*. *International Journal of Greenhouse Gas Control* **9**, 24–40
- Arasto A, Tsupari E, Kärki J, Pislä E & Sorsamäki L (2012). *Post-combustion capture of CO<sub>2</sub> at an integrated steel mill –part I: technical concept analysis*. *International Journal of Greenhouse Gas Control*. <http://dx.doi.org/10.1016/j.ijggc.2012.08.018>
- ArcelorMittal (2010). *Global technology roadmap for CCS in industry: sectoral assessment: steel*. Research report for UNIDO. <http://cdn.globalccsinstitute.com/sites/default/files/publications/15671/global-technology-roadmap-ccs-industry-steel-sectoral-report.pdf>
- Ashworth P, Quezada G, van Kasteran Y, et al. (2009). *Perceptions of low emission energy technologies: results from a Perth large group workshop*. *Energy Transformed Flagship*, June (2009). <http://www.csiro.au/en/Outcomes/Energy/Perceptions-of-low-emission-energy-technologies-Perth.aspx>
- Ashworth, P, Bradbury J, Feenstra, C, et al. (2011a). *Communication/engagement toolkit for CCS projects*. CSIRO, Australia, 48 pp. <http://cdn.globalccsinstitute.com/sites/default/files/publications/13571/publication-20110601-communication-engagement-toolkit.pdf>
- Ashworth P, Bradbury J, Feenstra C, et al. (2011b). *Communication, project planning and management for carbon capture and storage projects: an international comparison*. CSIRO. [http://www.csiro.au/Outcomes/Energy/~media/CSIROau/Flagships/Energy%20Transformed%20Flagship/InternatComparison\\_ETF\\_pdf%20Standard.pdf](http://www.csiro.au/Outcomes/Energy/~media/CSIROau/Flagships/Energy%20Transformed%20Flagship/InternatComparison_ETF_pdf%20Standard.pdf)
- Aspelund A & Jordal K (2007). *Gas conditioning – the interface between CO<sub>2</sub> capture and transport*. *International Journal of Greenhouse Gas Control* **1** (3), 343–354
- Bertier P, Swennen R, Laenen B, Lagrou D & Dreesen R (2006). *Experimental identification of CO<sub>2</sub>–water–rock interactions caused by sequestration of CO<sub>2</sub> in Westphalian and Buntsandstein sandstones of the Campine Basin (NE-Belgium)*. *Journal of Geochemical Exploration* **89**, 10–14.
- Best-Waldhober M, Daamen D & Faaij A (2009). *Informed and uninformed opinions on CO<sub>2</sub> capture and storage technologies in the Netherlands*. *International Journal of Greenhouse Gas Control* **3** (3), 322–332
- Bilio M, Brown S, Fairweather M & Mahgerefteh H (2009). *CO<sub>2</sub> pipelines material and safety considerations*. Hazards XXI, Symposium Series No. 155, 423–429
- BIOREF-INTEG (2009). *Overview innovative biorefinery concepts. Development of advanced biorefinery schemes to be integrated into existing industrial fuel producing complexes* (EU BIOREF-INTEG project, [http://www.bioref-integ.eu/fileadmin/bioref-integ/user/documents/Final\\_Report.pdf](http://www.bioref-integ.eu/fileadmin/bioref-integ/user/documents/Final_Report.pdf))
- Birkholzer J, Zhou Q & Tsang C-F (2009). *Large-scale impact of CO<sub>2</sub> storage in deep saline aquifers: a sensitivity study on pressure response in stratified systems*. *International Journal of Greenhouse Gas Control* **3**, 181–194
- Botero C, Belloni C, Finkenrath M, et al. (2009). *Thermodynamic assessment of CO<sub>2</sub> compression strategies for CO<sub>2</sub> capture applications*. In Proceedings of 3rd International CO<sub>2</sub> Forum, Abu Dhabi, UAR, 2 April 2009
- Bradbury J, Greenberg S & Wade S, (2011). *Communicating the risks of CCS*. <http://cdn.globalccsinstitute.com/sites/default/files/publications/21027/communicating-risks-ccs.pdf>
- Britt D, Furukawa H, Wang B, Glover G & Yaghi O (2009). *Highly efficient separation of carbon dioxide by a metal-organic framework replete with open metal sites*. Proceedings of the National Academy of Sciences of the United States of America **106** (49), 20637–20640
- Carbon Sequestration Leadership Forum (2009). *Technology roadmap*. [http://www.cslforum.org/publications/documents/CSLF\\_Technology\\_Roadmap.pdf](http://www.cslforum.org/publications/documents/CSLF_Technology_Roadmap.pdf).

- Carbon Capture and Storage Association (2011). *A strategy for CCS in the UK and beyond*. <http://www.ccsassociation.org.uk/press-centre/reports-and-publications/>
- Cefic (2011). *The chemical industry in europe: towards sustainability*. <http://www.cefic.org/sustainability-report-2012>
- Chiyoda Corporation (2011). *Preliminary feasibility study on CO<sub>2</sub> carrier for ship-based CCS*. Final report for Global CCS Institute, September 2011. <http://cdn.globalccsinstitute.com/sites/default/files/publications/24452/chiyoda-report-merged.pdf>
- Chrysostomidis I, Perumalpillai S & Wolff E (2012). *CCS stakeholder issues: review and analysis*. Final report by Environmental Resources Management for the CO<sub>2</sub> Capture Project, February 2012. [http://www.co2captureproject.com/reports/stakeholder\\_issues\\_report\\_March\\_2012.pdf](http://www.co2captureproject.com/reports/stakeholder_issues_report_March_2012.pdf)
- Corry O & Reiner D (2011). *Evaluating global Carbon Capture and Storage (CCS) communication materials: A survey of global CCS communications*. University of Cambridge, 46pp. <http://cdn.globalccsinstitute.com/sites/default/files/publications/19916/evaluating-global-carbon-capture-and-storage-ccs-communication-materials-survey-global-ccs-communicat.pdf>
- Crosdale J, Beamish B & Valix M (1998). *Coalbed methane sorption related to coal composition*. International Journal of Coal Geology **35**, 147–158
- Decarre S, Berthiaud J, Butin N & Guillaume-Combecave J (2010). *CO<sub>2</sub> maritime transportation*. International Journal of Greenhouse Gas Control **4** (5), 857–864 <http://www.sciencedirect.com/science/article/pii/S1750583610000794>
- DECC (2012). *CCS roadmap: supporting deployment of carbon capture and storage in the UK*. <http://www.decc.gov.uk/assets/decc/11/cutting-emissions/carbon-capture-storage/4899-the-ccs-roadmap.pdf>
- Desbarats J, Upham P, Riesch H, et al. (2010). *Review of the public participation practices for CCS and non-CCS projects in Europe*. Institute for European Environmental Policy, on behalf of the NEARCO<sub>2</sub> consortium, 208 pp. [http://www.communicationnearco2.eu/fileadmin/communicationnearco2/user/docs/WP1.2\\_Final\\_report.pdf](http://www.communicationnearco2.eu/fileadmin/communicationnearco2/user/docs/WP1.2_Final_report.pdf)
- Det Norske Veritas (2010). *Global technology roadmap for CCS in industry: sectoral assessment: refineries*. Research report for UNIDO. [http://cdn.globalccsinstitute.com/sites/default/files/publication\\_20100825\\_sector-assess-refineries.pdf](http://cdn.globalccsinstitute.com/sites/default/files/publication_20100825_sector-assess-refineries.pdf)
- Diego M, Aria B & Abanades J, (2012). *Modeling the solids circulation rates and solids inventories of an interconnected circulating fluidized bed reactor system for CO<sub>2</sub> capture by calcium looping*. Chemical Engineering Journal, **198–199**, 228–235
- Dillon D, Panesar R, Wall R, et al. (2004). *Oxy-combustion processes for CO<sub>2</sub> capture from advanced supercritical PF and NGCC power plant*. GHGT-7, Vancouver, Canada, 2004. <http://uregina.ca/ghgt7/PDF/papers/peer/145pdf>
- Dixon T (2012). *COP-18 Update and Outcomes from Doha*. IEAGHG information paper, 2012-IP18. [http://www.ieaghg.org/docs/General\\_Docs/Publications/Information\\_Papers/2012-IP18.pdf\\_COP-18\\_Outcomes.pdf](http://www.ieaghg.org/docs/General_Docs/Publications/Information_Papers/2012-IP18.pdf_COP-18_Outcomes.pdf)
- Ecofys (2007). *DYNAMIS CO<sub>2</sub> quality recommendations From Dynamis project (No 109672): towards hydrogen and electricity production with carbon dioxide capture and storage*. Report D 313. <http://www.sintef.no/project/dynamis-hypogen/Publications/D3-1-3%20DYNAMIS%20CO2%20quality%20recommendations%5B1%5D.pdf>
- Ehlig-Economides C & Economides M (2010). *Sequestering carbon dioxide in a closed underground volume*. Journal of Petroleum Science and Engineering **70**, 123–130
- Eiken O, Ringrose P, Hermanrud C, Nazarian B, Torp T & Høier L (2011). *Lessons learned from 14 years of CCS operations: Sleipner, In Salah and Snøhvit*. Energy Procedia **4**, 5541–5548
- Eiken O, Gilding D, Hansen H, et al. (2012). *Snøhvit: the history of injecting and storing 1 Mt CO<sub>2</sub> in the fluvial Tubåen Fm*. Energy Procedia (accepted for publication)
- Element Energy (2010). *CO<sub>2</sub> pipeline infrastructure: an analysis of global challenges and opportunities*. Final report for IEA Greenhouse Gas Programme, April 2010. <http://www.ccsassociation.org.uk/docs/2010/IEA%20Pipeline%20final%20report%20270410.pdf>
- Epple B & Ströhle J (2008). *CO<sub>2</sub> capture based on chemical and carbonate looping*. VGB PowerTech 11/2008, 85–89
- Epple B & Ströhle J (2011). *Chemical looping in power plants*. In Stolten D & Scherer V (editors), *Efficient carbon capture for coal power plants*. Weinheim, Germany: Wiley-VCH
- Eurobarometer (2011). *Public awareness and acceptance of CO<sub>2</sub> capture and storage*. Special Eurobarometer 364. [http://ec.europa.eu/public\\_opinion/archives/ebs/ebs\\_364\\_en.pdf](http://ec.europa.eu/public_opinion/archives/ebs/ebs_364_en.pdf)
- EASAC (2011). *Concentrating solar power: its potential contribution to a sustainable energy future*. EASAC policy report 16, November 2011. <http://www.easac.eu/home/reports-and-statements/detail-view/article/concentratin.html>
- EASAC (2012). *The current status of biofuels in the European Union, their environmental impacts and future prospects*. EASAC Policy Report 19. <http://www.easac.eu/home/reports-and-statements/detail-view/article/the-current.html>

European Cement Research Academy (ECRA) (2009). *ECRA CCS Project - report about phase II*. [http://www.ecra-online.org/fileadmin/redaktion/files/pdf/ECRA\\_Technical\\_Report\\_CCS\\_Phase\\_II.pdf](http://www.ecra-online.org/fileadmin/redaktion/files/pdf/ECRA_Technical_Report_CCS_Phase_II.pdf)

European Commission (2007a). *A European strategic energy technology plan (SET-plan): 'Towards a low carbon future'*. COM 2007 723 final. <http://eur-lex.europa.eu/LexUriServ/LexUriServ.do?uri=COM:2007:0723:FIN:EN:PDF>

European Commission (2007b). *Sustainable power generation from fossil fuels: aiming for near-zero emissions from coal after 2020*. Communication from the Commission COM2006 843 final Brussels, 10:01:2007. <http://eur-lex.europa.eu/LexUriServ/LexUriServ.do?uri=COM:2006:0843:FIN:EN:PDF>

European Commission (2007c). *An energy policy for Europe*. COM 2007 1 final. [http://ec.europa.eu/energy/energy\\_policy/doc/01\\_energy\\_policy\\_for\\_europe\\_en.pdf](http://ec.europa.eu/energy/energy_policy/doc/01_energy_policy_for_europe_en.pdf)

European Commission (2008a). *EU energy security and solidarity action plan: 2nd strategic energy review*. <http://eur-lex.europa.eu/LexUriServ/LexUriServ.do?uri=COM:2008:0781:FIN:EN:PDF>

European Commission (2008b). *Supporting early demonstration of sustainable power generation from fossil fuels*. COM2008 13 Final, Brussels, 23:01:2008. <http://eur-lex.europa.eu/LexUriServ/LexUriServ.do?uri=COM:2008:0013:FIN:EN:PDF>

European Commission (2008c). *Impact Assessment*. Accompanying document to the proposal for a Directive of the European Parliament and of the Council on the geological storage of carbon dioxide Commission Staff Working Document SEC2008 54. [http://ec.europa.eu/clima/policies/lowcarbon/ccs/docs/sec\\_2008\\_54\\_en.pdf](http://ec.europa.eu/clima/policies/lowcarbon/ccs/docs/sec_2008_54_en.pdf)

European Commission (2009a). *Directive 2009/31/EC of the European Parliament and of the Council of 23 April 2009 on the geological storage of carbon dioxide*. <http://eur-lex.europa.eu/LexUriServ/LexUriServ.do?uri=OJ:L:2009:140:0114:0135:EN:PDF>

European Commission (2009b). *Investing in the development of low carbon technologies (SET-Plan)* Communication from the Commission COM2009 519 final Brussels, 07:10:2009. <http://eur-lex.europa.eu/LexUriServ/LexUriServ.do?uri=COM:2009:0519:FIN:EN:PDF>

European Commission (2009c). *A Technology Roadmap* Commission Staff Working Document SEC(2009). 1295 Brussels, 07:10:2009. <http://eur-lex.europa.eu/LexUriServ/LexUriServ.do?uri=SEC:2009:1295:FIN:EN:PDF>

European Commission (2009d). *Directive 2009/29/EC of the European Parliament and of the Council of 23 April 2009 amending Directive 2003/87/EC so as to improve and extend the greenhouse gas emission allowance*

*trading scheme of the Community*. <http://eur-lex.europa.eu/LexUriServ/LexUriServ.do?uri=OJ:L:2009:140:0063:0087:EN:PDF>

European Commission (2010a). *CO<sub>2</sub> capture and storage: Demonstration projects supported by the European Energy Programme for Recovery*. Directorate-General for Energy [http://ec.europa.eu/energy/publications/doc/2010\\_eep\\_r\\_brochure\\_co2\\_en.pdf](http://ec.europa.eu/energy/publications/doc/2010_eep_r_brochure_co2_en.pdf)

European Commission (2010b). *Energy 2020: A strategy for competitive, sustainable and secure energy* Communication from the Commission COM2010 639 final. <http://eur-lex.europa.eu/LexUriServ/LexUriServ.do?uri=COM:2010:0639:FIN:EN:PDF>

European Commission (2010c). *Call for proposals concerning the financing of commercial demonstration projects that aim at the environmentally safe capture and geological storage of CO<sub>2</sub>, as well as demonstration projects of innovative renewable energy technologies under the scheme for greenhouse gas emission allowance trading within the Community, established by Directive 2003/87/EC*. [http://ec.europa.eu/clima/funding/ner300/docs/call\\_en.pdf](http://ec.europa.eu/clima/funding/ner300/docs/call_en.pdf)

European Commission (2011a). *Implementation of Directive 2009/31/EC on the Geological Storage of Carbon Dioxide: Guidance Document 1: CO<sub>2</sub> Storage Life Cycle Risk Management Framework*. [http://ec.europa.eu/clima/policies/lowcarbon/docs/gd1\\_en.pdf](http://ec.europa.eu/clima/policies/lowcarbon/docs/gd1_en.pdf)

European Commission (2011b). *A Roadmap for moving to a competitive low carbon economy in 2050*. Communication from the Commission, 832011, COM2011 112 final. [http://ec.europa.eu/clima/documentation/roadmap/docs/com\\_2011\\_112\\_en.pdf](http://ec.europa.eu/clima/documentation/roadmap/docs/com_2011_112_en.pdf)

European Commission (2011c). *Implementation of Directive 2009/31/EC on the Geological Storage of Carbon Dioxide: Guidance Document 2: Characterisation of the storage complex, CO<sub>2</sub> stream composition, monitoring and corrective measures*. [http://ec.europa.eu/clima/policies/lowcarbon/docs/gd2\\_en.pdf](http://ec.europa.eu/clima/policies/lowcarbon/docs/gd2_en.pdf)

European Commission (2011d). *Implementation of Directive 2009/31/EC on the Geological Storage of Carbon Dioxide: Guidance Document 3: Criteria for transfer of responsibility to the competent authority*. [http://ec.europa.eu/clima/policies/lowcarbon/docs/gd3\\_en.pdf](http://ec.europa.eu/clima/policies/lowcarbon/docs/gd3_en.pdf)

European Commission (2011e). *Implementation of Directive 2009/31/EC on the Geological Storage of Carbon Dioxide: Guidance Document 4: Article 19 financial security and Article 20 financial mechanism*. [http://ec.europa.eu/clima/policies/lowcarbon/docs/gd4\\_en.pdf](http://ec.europa.eu/clima/policies/lowcarbon/docs/gd4_en.pdf)

European Commission (2011f). *Energy roadmap 2050*. COM2011 885 final. [http://ec.europa.eu/energy/energy2020/roadmap/index\\_en.htm](http://ec.europa.eu/energy/energy2020/roadmap/index_en.htm)

- European Commission (2011g). *Impact Assessment accompanying Energy Roadmap 2050* Commission Staff Working Paper, SEC2011 1565 Part 2/2. [http://ec.europa.eu/energy/energy2020/roadmap/doc/sec\\_2011\\_1565\\_part2.pdf](http://ec.europa.eu/energy/energy2020/roadmap/doc/sec_2011_1565_part2.pdf)
- European Commission (2011h). *Proposal for a regulation of the European Parliament and of the Council on guidelines for trans-European infrastructure and repealing Decision No 1364/2006/EC*. <http://eur-lex.europa.eu/LexUriServ/LexUriServ.do?uri=COM:2011:0658:FIN:EN:PDF>
- European Commission (2012a). *Award decision under the first call for proposals of the NER300 funding programme*. [http://ec.europa.eu/clima/news/docs/c\\_2012\\_9432\\_en.pdf](http://ec.europa.eu/clima/news/docs/c_2012_9432_en.pdf)
- European Commission (2012b). *Report from the Commission to the European Parliament and the Council on the implementation of the European Energy Programme for Recovery COM2012 445 final*. [http://ec.europa.eu/energy/eepr/doc/com\\_2012\\_0445\\_en.pdf](http://ec.europa.eu/energy/eepr/doc/com_2012_0445_en.pdf)
- European Commission (2013a). *Communication from the Commission to the European Parliament, the Council, the European Economic and Social Committee and the Committee of the Regions on the Future of Carbon Capture and Storage in Europe COM2013 180 final*. [http://ec.europa.eu/energy/coal/doc/com\\_2013\\_0180\\_ccs\\_en.pdf](http://ec.europa.eu/energy/coal/doc/com_2013_0180_ccs_en.pdf)
- European Commission (2013b). *Green paper: A 2030 Framework for climate and energy policies*, COM2013 169 final. [http://ec.europa.eu/energy/consultations/doc/com\\_2013\\_0169\\_green\\_paper\\_2030\\_en.pdf](http://ec.europa.eu/energy/consultations/doc/com_2013_0169_green_paper_2030_en.pdf)
- European Environment Agency (2011a). *Air pollution impacts from carbon capture and storage (CCS)*. Technical report no. 14/2011. <http://www.eea.europa.eu/publications/carbon-capture-and-storage>
- European Environment Agency (2011b). *Annual European Union greenhouse gas inventory 1990-2009 and inventory report 2011*. European Environment Agency Technical report no. 2/2011. <http://www.eea.europa.eu/publications/european-union-greenhouse-gas-inventory-2011>
- European Environment Agency Scientific Committee on Greenhouse Gas Accounting in Relation to Bioenergy (2011). *Opinion in relation to bioenergy 15 September 2011*. <http://www.eea.europa.eu/about-us/governance/scientific-committee/sc-opinions/opinions-on-scientific-issues/sc-opinion-on-greenhouse-gas/view>
- European Union (2007). *Treaty of Lisbon amending the Treaty of the European Union and the Treaty establishing the European Community 2007/c 306/01*. <http://eur-lex.europa.eu/JOHtml.do?uri=OJ:C:2007:306:SOM:EN:HTML>
- Evans K, Zappone A, Kraft T, Deichmann N & Moia F (2012). *A survey of the induced seismic responses to fluid injection in geothermal and CO<sub>2</sub> reservoirs in Europe*. *Geothermics* **41**, 30–54
- Evar B, Armeni C & Scott V, (2012). *An introduction to key developments and concepts in CCS*. In Markusson N, Shackley S & Evar B (editors), *The social dynamics of carbon capture and storage*. Abingdon, UK: Routledge, Taylor and Francis
- Follmann P, Bayer C, Wessling M & Melin T (2011). *CO<sub>2</sub> separation via the post-combustion process with membranes in coal power plants*. In Stolten D & Scherer V (editors), *Efficient carbon capture for coal power plants*. Weinheim, Germany: Wiley-VCH
- Gale J (2012). *Rebuttal to Zoback paper*. IEAGHG Information Paper 2012-IP1. [http://www.ieaghg.org/docs/General\\_Docs/Publications/Information\\_Papers/2012-IP1.pdf\\_Rebuttal\\_to\\_Zoback\\_Paper.pdf](http://www.ieaghg.org/docs/General_Docs/Publications/Information_Papers/2012-IP1.pdf_Rebuttal_to_Zoback_Paper.pdf)
- GeoCapacity (2009). *EU GeoCapacity: assessing European capacity for geological storage of carbon dioxide WP2 Report: storage capacity D16*. <http://www.geology.cz/geocapacity/publications/D16%20WP2%20Report%20storage%20capacity-red.pdf>
- Gerdemann S, O'Connor W, Dahlin D, Penner L & Rush H (2007). *Ex situ aqueous mineral carbonation*. *Environmental Science & Technology* **41** (7), 2587–2593
- GESTCO (2004). *Geological storage of CO<sub>2</sub> from combustion of fossil fuel*. EU 5th Framework Programme for R&D project no ENK6-CT-1999-00010 Summary report, November 2004. [http://www.geus.dk/program-areas/energy/denmark/co2/GESTCO\\_summary\\_report\\_2ed.pdf](http://www.geus.dk/program-areas/energy/denmark/co2/GESTCO_summary_report_2ed.pdf)
- Gjernes E, Helgesen L & Maree Y (2013). *Health and environmental impact of amine based post combustion CO<sub>2</sub> capture*. Submitted to Energy Procedia. <http://www.tcmda.com/Global/Dokumenter/GjernesHelgesenMaree-sent.pdf>
- Global CCS Institute (2011a). *Accelerating the uptake of CCS: industrial use of capture carbon dioxide*. <http://cdn.globalccsinstitute.com/sites/default/files/publications/14026/accelerating-uptake-ccs-industrial-use-captured-carbon-dioxide.pdf>
- Global CCS Institute (2011b). *The global status of CCS: 2011*. Canberra, Australia, 143 pp. [http://cdn.globalccsinstitute.com/sites/default/files/the\\_global\\_status\\_ccs\\_2011.pdf](http://cdn.globalccsinstitute.com/sites/default/files/the_global_status_ccs_2011.pdf)
- Global CCS Institute (2011c). *The costs of CCS and other low carbon technologies*. Issues Brief No 2, Canberra, Australia. <http://cdn.globalccsinstitute.com/sites/default/files/publications/24202/costs-ccs-and-other-low-carbon-technologies.pdf>
- Global CCS Institute (2011d). *Economic assessment of carbon capture and storage technologies: 2011 update*. Canberra, Australia. Report prepared by WorleyParsons

- and Schlumberger. <http://www.globalccsinstitute.com/publications/economic-assessment-carbon-capture-and-storage-technologies-2011-update>
- Global CCS Institute (2012a). *CO<sub>2</sub> capture technologies: pre combustion capture*. January 2012. <http://www.globalccsinstitute.com/publications/co2-capture-technologies-pre-combustion-capture>
- Global CCS Institute (2012b). *CO<sub>2</sub> capture technologies oxy combustion with CO<sub>2</sub> capture*. <http://cdn.globalccsinstitute.com/sites/default/files/publications/29761/co2-capture-technologies-oxy-combustion.pdf>
- Global CCS Institute (2012c). *CO<sub>2</sub> capture technologies technology options for CO<sub>2</sub> capture*. <http://www.globalccsinstitute.com/publications/technology-options-co2-capture>
- Global CCS Institute (2012d). *The global status of CCS 2012*. <http://www.globalccsinstitute.com/publications/global-status-ccs-2012>
- Goodyear S, Hawkyard I, Masters J & Woods C (2002). *Subsurface issues for CO<sub>2</sub> flooding of UKCS reservoirs*. Paper presented at the DTI's Improved Oil Recovery Research Dissemination Seminar, 25 June 2002
- Hack H, Alvarez I, Diego R, et al. (2012). *Initial operation of the CIUDEN Oxy-CFB boiler demonstration project*. 11th Annual Conference on Carbon Capture, Utilization & Sequestration Pittsburgh, Pennsylvania, 2012
- Hammond J & Shackley S (2010). *Towards a public engagement and communication strategy for carbon dioxide capture and storage projects in Scotland*. Scottish Carbon Capture and Storage Centre, Working Paper SCCS 2010-08. [http://www.geos.ed.ac.uk/sccs/SCCTS\\_WP4\\_Final\\_Report.pdf](http://www.geos.ed.ac.uk/sccs/SCCTS_WP4_Final_Report.pdf)
- Han W, McPherson B, Lichtner P & Wang F (2010). *Evaluation of trapping mechanisms in geologic CO<sub>2</sub> sequestration: case study of SACROC northern platform, a 35-year CO<sub>2</sub> injection site*. *American Journal of Science* **310** (4), 282–324
- Hansson A (2012). *Colonizing the future*. In Markusson N, Shackley S & Evar B (editors), *The social dynamics of carbon capture and storage*. Abingdon, UK: Routledge, Taylor and Francis
- Harmelen T, Koornneef J, Horssen A, Ramírez A & Van Gijlswijk R (2008). *The impacts of CO<sub>2</sub> capture technologies on transboundary air pollution in the Netherlands*. TNO and University of Utrecht, Utrecht, the Netherlands. <http://igitur-archive.library.uu.nl/chem/2009-0310-203446/NWS-E-2008-30.pdf>
- Harper P, (2011). *Assessment of the major hazard potential of carbon dioxide (CO<sub>2</sub>)*. UK Health and Safety Executive. <http://www.hse.gov.uk/carboncapture/major-hazard-potential-carbon-dioxide.pdf>
- Harvey L (2008). *Mitigating the atmospheric CO<sub>2</sub> increase and ocean acidification by adding limestone powder to upwelling regions*. *Journal of Geophysical Research* **113**, C04028, doi:10.1029/2007JC004373
- Herri J-P (2011). *CO<sub>2</sub> capture by using clathrates*. Presented at EU–China Workshop on Innovative CCS Technologies, 19–20 September 2011, Beijing, China. [http://icapco2.org/empty\\_17.html](http://icapco2.org/empty_17.html)
- Hildenbrand A, Krooss B, Busch A & Gaschnitz R, (2006). *Evolution of methane sorption capacity of coal seams as a function of burial history—a case study from the Campine Basin, NE Belgium*. *International Journal of Coal Geology* **66**, 179–203
- Hinc (2012). *CCS in Europe – the way forward*. Demos EUROPA Centre for European Strategy, July 2012. [http://www.demoservices.home.pl/www/files/CCS%20in%20Europe%20-%20the%20way%20forward\\_Agata%20Hinc.pdf](http://www.demoservices.home.pl/www/files/CCS%20in%20Europe%20-%20the%20way%20forward_Agata%20Hinc.pdf)
- Ho M (2008). *Reducing the cost of CO<sub>2</sub> capture from flue gases using membrane technology*. *Industrial and Engineering Chemistry Research* **47**, 1562–1568
- Hooper B (2012). *The 'UNO MK3' system – reducing the cost of capturing CO<sub>2</sub>*. All Energy Conference, Melbourne, October 2012. <http://www.all-energy.net.au/userfiles/file/Barry-Hooper-101012.pdf>
- iCAP (2012). *EU-project Innovative CO<sub>2</sub> capture (iCAP) under the 7th Framework Programme of the EU* <http://icapco2.org/>
- IEA (2009). *Technology roadmap: carbon capture and storage*. [http://www.iea.org/publications/freepublications/publication/CCS\\_Roadmap.pdf](http://www.iea.org/publications/freepublications/publication/CCS_Roadmap.pdf)
- IEA (2010). *Energy technology perspectives 2010: scenarios and strategies to 2050*. <http://www.iea.org/publications/freepublications/publication/etp2010.pdf>
- IEA (2011). *Cost and performance of carbon dioxide capture from power generation*. Working Paper prepared by Mathias Finkenrath. [http://www.iea.org/publications/freepublications/publication/costperf\\_ccs\\_powergen-1.pdf](http://www.iea.org/publications/freepublications/publication/costperf_ccs_powergen-1.pdf)
- IEA and United Nations Industrial Development Organization (2011). *Technology roadmap: carbon capture and storage in industrial applications*. [http://www.iea.org/publications/freepublications/publication/ccs\\_industry.pdf](http://www.iea.org/publications/freepublications/publication/ccs_industry.pdf)
- IEA Greenhouse Gas R&D Programme (2004). *Ship transport of CO<sub>2</sub>*. IEAGHG report PH4/30, July 2004
- IEA Greenhouse Gas R&D Programme (2007). *Capturing CO<sub>2</sub>*. [http://www.ieaghg.org/docs/general\\_publications/cocapture.pdf](http://www.ieaghg.org/docs/general_publications/cocapture.pdf)

- IEA Greenhouse Gas R&D Programme (2008a). *Geologic storage of carbon dioxide: staying safely underground*. [http://ccs101.ca/assets/Documents/relatedlinks/ccs\\_brochure.pdf](http://ccs101.ca/assets/Documents/relatedlinks/ccs_brochure.pdf)
- IEA Greenhouse Gas R&D Programme (2008b). *CO<sub>2</sub> capture in the cement industry*. Technical Report No 2008/3, July 2008
- IEA Greenhouse Gas R&D Programme (2011a). *Ship transport of CO<sub>2</sub>: review of work underway*. GHG/11/51 for 40th Executive Committee Meeting
- IEA Greenhouse Gas R&D Programme (2011b). *Retrofitting CO<sub>2</sub> capture to existing power plants*. Technical Report 2011/02, May 2011.
- IEA Greenhouse Gas R&D Programme (2012a). *Risk scenarios database*. <http://www.ieaghg.org/index.php/?/20091223132/risk-scenarios-database.html>
- IEA Greenhouse Gas R&D Programme (2012b). *Gaseous emissions from amine based PCC processes and their deep removal*. Technical Report 2012/07
- Insight Economics (2011). *Development of carbon capture and storage infrastructure: building essential infrastructure for carbon capture and storage*. Report commissioned by the Global CCS Institute. <http://www.globalccsinstitute.com/publications/development-carbon-capture-and-storage-infrastructure>
- Intergovernmental Panel on Climate Change (IPCC) (2005). *Carbon dioxide capture and storage*. A Special Report of Working Group III of the Intergovernmental Panel on Climate Change. [http://www.ipcc.ch/pdf/special-reports/srrcs/srrcs\\_wholereport.pdf](http://www.ipcc.ch/pdf/special-reports/srrcs/srrcs_wholereport.pdf)
- Jockenhoevel T, Schneider R & Rode H (2009). *Development of an economic post-combustion carbon capture process*. Energy Procedia **1**, 1043–1050
- Joint Research Centre (2011). *2011 Technology map of the European Strategic Energy Technology Plan (SET-Plan). Technology descriptions*. [http://setis.ec.europa.eu/about-setis/technology-map/2011\\_Technology\\_Map1.pdf/view](http://setis.ec.europa.eu/about-setis/technology-map/2011_Technology_Map1.pdf/view)
- JPC Corp and BASF SE (2012). *HiPACT (High Pressure Acid-gas Capture Technology) process*. <http://www.jgc.co.jp/en/04tech/01gas/hipact.html>
- Kahan D, Jenkins-Smith H, Braman D (2011). *Cultural cognition of scientific consensus*. Journal of Risk Research **14** (2), 147–174
- Karadas F, Atilhan M & Aparicio S (2010). *Review on the use of ionic liquids (ILs) as alternative fluids for CO<sub>2</sub> capture and natural gas sweetening*. Energy Fuels **24**, 5817–5828
- Kharaka Y, Cole D, Hovorka S, Gunter W, Knauss K & Freifeld B (2006). *Gas-water-rock interactions in Frio Formation following CO<sub>2</sub> injection: implications for the storage of greenhouse gases in sedimentary basins*. Geology, **34** (7), 577–580
- Knudsen J, Andersen J, Jensen J & Biede O, (2011). *Evaluation of process upgrades and novel solvents for the post combustion CO<sub>2</sub> capture process in pilot-scale*. Energy Procedia **4**, 1558–1565
- Koornneef J, Ramirez A, van Harmelen T, van Horssen A, Turkenburg W & Faaij A (2010). *The impact of CO<sub>2</sub> capture in the power and heat sector on the emission of SO<sub>2</sub>, NO<sub>x</sub>, particulate matter, volatile organic compounds and NH<sub>3</sub> in the European Union*. Atmospheric Environment **44** (11), 1369–1385
- Koornneef J, van Harmelen T, van Horssen A & Ramirez A (2011). *Carbon dioxide capture and air quality*. In: Mazzeo N (editor), *Chemistry, emission control, radioactive pollution and indoor air quality, 2011*. InTech, Rijeka, Croatia. <http://www.intechopen.com/books/chemistry-emission-control-radioactive-pollution-and-indoor-air-quality/carbon-dioxide-capture-and-air-quality>
- Kozak F, Petig A, Morris E, Rhudy R & Thimsen D (2009). *Chilled ammonia process for CO<sub>2</sub> capture*. Energy Procedia **1** (1), 1419–1426
- Kuijper M (2011). *Public acceptance challenges for onshore CO<sub>2</sub> storage in Barendrecht*. Energy Procedia **4**, 6226–6233
- Kuramochi T, Ramirez A, Turkenburg W & Faaij A (2012). *Comparative assessment of CO<sub>2</sub> capture technologies for carbon-intensive industrial processes*. Progress in Energy and Combustion Science **38** (1), 87–112
- Lackner K, Wendt C, Butt D, Joyce Jr E & Sharp D (1995). *Carbon dioxide disposal in carbonate minerals*. Energy **20** (11), 1153–1170
- Lehmann J (2007). *Bio-energy in the black*. Frontiers in Ecology and the Environment **5** (7), 381–387
- Leopoldina (2012). *Bio-energy – chances and limits*. Executive summary and recommendations. [http://www.leopoldina.org/uploads/tx\\_leopublication/201207\\_Bioenergie\\_Stellungnahme\\_kurz\\_de\\_en\\_Okt2012\\_01.pdf](http://www.leopoldina.org/uploads/tx_leopublication/201207_Bioenergie_Stellungnahme_kurz_de_en_Okt2012_01.pdf)
- Lewicki J, Birkholzer J & Tsang C (2007). *Natural and industrial analogues for leakage of CO<sub>2</sub> from storage reservoirs: identification of features, events and processes and lessons learned*. Environmental Geology, **52** (3) 457–467
- Li J-R (2011). *Carbon dioxide capture-related gas adsorption and separation in metal-organic frameworks*. Coordination Chemistry Reviews **255**, 1791–1823
- Liebenthal U, Linnenberg S, Oexmann J & Kather A (2011). *Derivation of correlations to evaluate the impact of retrofitted post-combustion CO<sub>2</sub> capture processes on steam power plant performance*. International Journal of Greenhouse Gas Control **5**, 1232–1239
- Liu Q & Maroto-Valer M (2011). *Parameters affecting mineral trapping of CO<sub>2</sub> sequestration in brines*. Greenhouse Gas Sci Technol **1**, 211–222

- Lowe P (2012). Presentation to the 3rd Annual Brussels Carbon Capture and Storage Summit 2012. Brussels, 15 May 2012. [http://www.eu-ems.com/agenda.asp?event\\_id=102&page\\_id=749](http://www.eu-ems.com/agenda.asp?event_id=102&page_id=749)
- Mabon L, Vercelli S, Shackley S, Anderlucchi J & Boot K (2012). *Carbon capture and storage public perception factors: literature review and open issues*. ECO<sub>2</sub> project deliverable 61, January 2012. <http://www.eco2-project.eu/deliverables-and-publications.html>
- Mahgerefteh H, Brown S & Denton G (2012). *Modelling the impact of stream impurities on ductile fractures in CO<sub>2</sub> pipelines*. Chemical Engineering Science **74**, 200–210
- Major Economies Forum (2009). *Carbon capture, use and storage: technology action plan December 2009*. <http://www.majoreconomiesforum.org/images/stories/documents/MEF%20CCUS%20TAP%2011Dec2009.pdf>
- Mazzotti M, Pini R & Storti G (2008). *Enhanced coalbed methane recovery*. Journal of Supercritical Fluids **46**, 619–627
- Mazzotti M, Baciocchi R, Desmond M & Socolow R (2013). *Direct air capture of CO<sub>2</sub> with chemicals: optimization of a two-loop hydroxide carbonate system using a countercurrent air-liquid contactor*. Climate Change **116** (2). <http://link.springer.com/article/10.1007%2Fs10584-012-0679-y>
- McDaniels D & Bowen F (2010). *Public engagement and carbon capture and storage: lessons from Lacq*. IRIS Executive Briefing, Haskane School of Business, University of Calgary. [http://www.iseee.ca/media/uploads/documents/pdfs/researchreports/public\\_engage\\_CCS\\_lessons\\_lacq.pdf](http://www.iseee.ca/media/uploads/documents/pdfs/researchreports/public_engage_CCS_lessons_lacq.pdf)
- McGrail B, Schaef H, Ho A, Chien Y-J, Dooley J & Davidson C (2006). *Potential for carbon dioxide sequestration in flood basalts*. Journal of Geophysical Research and Solid Earth **111**, B12201, 13 pp
- McKinsey & Company (2010). *Impact of the financial crisis on carbon economics*. Version 21 of the Global Greenhouse Gas Abatement Cost Curve. [http://www.mckinsey.com/en/Client\\_Service/Sustainability/Latest\\_thinking/%7E/media/McKinsey/dotcom/client\\_service/Sustainability/cost%20curve%20PDFs/ImpactFinancialCrisisCarbonEconomicsGHGcostcurveV21.ashx](http://www.mckinsey.com/en/Client_Service/Sustainability/Latest_thinking/%7E/media/McKinsey/dotcom/client_service/Sustainability/cost%20curve%20PDFs/ImpactFinancialCrisisCarbonEconomicsGHGcostcurveV21.ashx)
- Meadowcroft J & Langhelle O (editors) (2009). *Caching the carbon. The politics and policy of carbon capture and storage*. Cheltenham, UK: Edward Elgar
- Mitchell R (2008). *Mitsubishi's carbon capture technology*. Carbon Capture Journal, January–February 2008. [http://www.mhi.co.jp/en/products/pdf/articles\\_05.pdf](http://www.mhi.co.jp/en/products/pdf/articles_05.pdf)
- Moritis G (2008). *Special report: more US EOR projects start but EOR production continues to decline*. Oil and Gas Journal **106** (15), 41–46
- Moser P, Schmidt S, Sieder G, Garcia H, Stoffregen T & Stamatov V (2011). *The post-combustion capture pilot plant Niederaussem—results of the first half of the testing programme*. Energy Procedia **4**, 1310–1316
- Mott MacDonald (2010). *Global technology roadmap for CCS in industry: sectoral assessment: cement*. Research report for UNIDO. [http://cdn.globalccsinstitute.com/sites/default/files/publication\\_20100802\\_sector-assessment\\_cement\\_0.pdf](http://cdn.globalccsinstitute.com/sites/default/files/publication_20100802_sector-assessment_cement_0.pdf)
- MVV Consulting (2007). *Implementation of TEN-E projects (2004-2006): evaluation and analysis*. Final report for DG-TREN, Volume 1, November 2007. [http://ec.europa.eu/energy/infrastructure/studies/doc/2007\\_11\\_ten\\_e\\_evaluation.pdf](http://ec.europa.eu/energy/infrastructure/studies/doc/2007_11_ten_e_evaluation.pdf)
- National Research Council (2012). *Induced seismicity potential in energy technologies*. [http://www.nap.edu/catalog.php?record\\_id=13355](http://www.nap.edu/catalog.php?record_id=13355)
- Neele F, Koenen M, Seebregts A, van Deurzen J, Kersemakers K & Mastenbroek M (2010). *Development of a large-scale CO<sub>2</sub> transport infrastructure in Europe: matching captured volumes and storage availability*. CO<sub>2</sub>Europe, <http://www.co2europipe.eu/Publications/D2.2.1%20-%20CO2Europipe%20Report%20CCS%20infrastructure.pdf>
- NETL (2009b). *Best practices for: public outreach and education for carbon storage projects*. Department of Energy (US), Report DOE/NETL-2009/1391, 62 pp. [http://www.netl.doe.gov/technologies/carbon\\_seq/refshelf/BPM\\_PublicOutreach.pdf](http://www.netl.doe.gov/technologies/carbon_seq/refshelf/BPM_PublicOutreach.pdf)
- Nilsson G, Dixon D, Domenici P, et al. (2012). *Near-future carbon dioxide levels alter fish behaviour by interfering with neurotransmitter function*. Nature Climate Change **2**, 201–204
- Nooner S, Eiken O, Hermanrud C, Sasagawa G, Stenvold T & Zumberge M (2007). *Constraints on the in situ density of CO<sub>2</sub> within the Utsira formation from time-lapse seafloor gravity measurements*. International Journal of Greenhouse Gas Control, **1**, 198–214
- O'Connor W, Dahlin D, Rush G, Gerdemann S, Penner L, Nilsen D (2005). *Aqueous mineral carbonation*. Final report DOE/ARC-TR-04-002, 15 March 2005. [http://www.netl.doe.gov/technologies/carbon\\_seq/refshelf/NETLAlbanyAqueousMineralCarbonation.pdf](http://www.netl.doe.gov/technologies/carbon_seq/refshelf/NETLAlbanyAqueousMineralCarbonation.pdf)
- Onuma T & Ohkawa S (2009). *Detection of surface deformation related to CO<sub>2</sub> injection by DInSAR at In Salah, Algeria* Energy Procedia **1**, 2177–2184 OSPAR, 2007. *New initiatives on CO<sub>2</sub> capture and storage and marine litter*. [http://www.ospar.org/content/news\\_detail.asp?menu=00600725000000\\_000002\\_000000](http://www.ospar.org/content/news_detail.asp?menu=00600725000000_000002_000000)
- Ove Arup & Partners Ltd (2010). *Feasibility study for Europe-wide CO<sub>2</sub> infrastructures*. TREN/372-1/C3/2009 for European Commission Directorate-General Energy, October 2010. [http://www.sccs.org.uk/Arup\\_SCCS\\_Feasibility\\_study\\_for\\_Europe\\_wide\\_co2\\_infrastructures.pdf](http://www.sccs.org.uk/Arup_SCCS_Feasibility_study_for_Europe_wide_co2_infrastructures.pdf)
- Owens S (2004). *Siting, sustainable development and social priorities*. Journal of Risk Research **7** (2), 101–114

- Oye V, Aker E, Daley T, Kühn D, Bohloli B & Korneev V (2012). *Microseismic monitoring and interpretation of injection data from the In Salah CO<sub>2</sub> storage site (Krechba), Algeria*. Energy Procedia (accepted for publication, available online at [www.sciencedirect.com](http://www.sciencedirect.com))
- Parsons Brinckerhoff (2011). *Accelerating the uptake of CCS: industrial use of captured carbon dioxide*. Global CCS Institute, March 2011. <http://cdn.globalccsinstitute.com/sites/default/files/publications/14026/accelerating-uptake-ccs-industrial-use-captured-carbon-dioxide.pdf>
- Pham V, Lu P, Aagaard P, Zhu C & Hellevang H (2011). *On the potential of CO<sub>2</sub>-water-rock interaction for CO<sub>2</sub> storage using a modified kinetic model*. International Journal of Greenhouse Gas Control, **5** (4), 1002–1015
- Pini R, Ottiger S, Burlini L, Storti G & Mazzotti M (2009). *Role of adsorption and swelling on the dynamics of gas injection in coal*. Journal of Geophysical Research [Solid Earth], **114**, article B04203
- Pini R, Ottiger S, Burlini L, Storti G & Mazzotti M (2010). *Sorption of carbon dioxide, methane and nitrogen in dry coals at high pressure and moderate temperature*. International Journal of Greenhouse Gas Control, **4**, 90–101
- Pini R, Storti G & Mazzotti M (2011). *A model for enhanced coal bed methane recovery aimed at carbon dioxide storage*. Adsorption **17**, 889–900
- Quaghebeur M, Nielsen P, Laenen B, Nguyen E & Van Mechelen D (2010). *Carbstone: sustainable valorisation technology for fine grained steel slags and CO<sub>2</sub>*. Refractories Worldforum, **2** (2), 75–79
- Quintrell M & Foster E (2011). *Integration of Ion Transport Membrane Technology with Oxy-combustion Power Generation Systems*. Presented at the 2nd IEAGHG International Oxyfuel Combustion Conference Yeppoon, Australia, 12–16 September 2011
- Raynal, L, Bouillon, P-A, Gomez, A & Broutin, P, (2011). *From MEA to demixing solvents and future steps, a roadmap for lowering the cost of post-combustion carbon capture*. Chemical Engineering Journal **171** (3), 742–752
- Reddy S, Scherffius J, Freguia S & Roberts C (2003). *Fluor's Econamine FG PlusSM Technology: an enhanced amine-based CO<sub>2</sub> capture process*. Presented at the Second National Conference on Carbon Sequestration National Energy Technology Laboratory/Department of Energy, Alexandria, Virginia, 5–8 May 2003. <http://netl.doe.gov/publications/proceedings/03/carbon-seq/PDFs/169.pdf>
- Reddy S, Johnson D & Gilmartin J, (2008). *Fluor's Econamine FG PlusSM Technology for CO<sub>2</sub> capture at coal-fired power plants*. Presented at Power Plant Air Pollutant Control 'Mega' Symposium, 25–28 August 2008, Baltimore, USA. <http://mitei.mit.edu/system/files/reddy-johnson-gilmartin.pdf>
- Reiner D (2008). *A looming rhetorical gap: a survey of public communications for carbon dioxide capture and storage technologies*. Judge Business School, University of Cambridge, January 2008. <http://www.eprg.group.cam.ac.uk/wp-content/uploads/2008/11/eprg08012.pdf>
- Reiner D & Nuttall W (2011). *Public acceptance of geological disposal of carbon dioxide and radioactive waste: similarities and differences*. In: Toth F (editor), *Geological disposal of carbon dioxide and radioactive waste: a comparative assessment*, Advances in Global Change Research, vol. 44. Springer
- Rice S (2004). *Human health risk assessment of CO<sub>2</sub>: survivors of acute high-level exposure and populations sensitive to prolonged low-level exposure*. Third Annual Conference on Carbon Sequestration, 3–6 May, Alexandria, Virginia, USA. <http://www.netl.doe.gov/publications/proceedings/04/carbon-seq/169.pdf>
- Royal Society (2009). *Geoengineering the climate: science, governance and uncertainty*. <http://royalsociety.org/policy/publications/2009/geoengineering-climate/>
- Rutqvist J, Vasco D & Myer L (2010). *Coupled reservoir-geomechanical analysis of CO<sub>2</sub> injection and ground deformations at In Salah, Algeria*. International Journal of Greenhouse Gas Control **4**, 225–230
- Santos S (2011). *Evaluation and analysis of water usage of power plants with CO<sub>2</sub> capture*. Clean Coal Technology Conference Zaragoza, Spain, May 2011
- Shaffer G (2010). *Long-term effectiveness and consequences of carbon dioxide sequestration*. Nature Geoscience **3**, 464–467
- Scheffknecht G, Al-Makhadmeh L, Schnell U & Maier J (2011). *Oxy-fuel coal combustion: a review of the current state-of-the-art*. International Journal of Greenhouse Gas Control **55**, S16–S35
- Schmidt M, Torn M, Abiven S, et al. (2010). *Scrutinizing the impact of CCS communication on the general and local public*. Final project report, March 2010. <http://www.ccs-communications.gr/reports/WP3%20final%20cross-regional%20report.pdf>
- Shackley S, Waterman H, Godfroij P, et al. (2007). *Stakeholder perceptions of CO<sub>2</sub> capture and storage in Europe: results from the EU-funded ACCSEPT survey*. Deliverable D31 from ACCSEPT – main report, April 2007. [http://www.accsept.org/outputs/main\\_survey\\_report.pdf](http://www.accsept.org/outputs/main_survey_report.pdf)
- Shackley S & Evar B (2009). *Public understanding, engagement and communication efforts on CCS: a review for the IEA CCS Roadmap*. IEA, Paris. <http://carbcap.geos.ed.ac.uk/website/publications/scs-wp/wp-2010-08.pdf>

- Shi J & Durucan S (2005). *CO<sub>2</sub> storage in deep unminable coal seams*. *Oil & Gas Science and Technology, IFP*, **60** (3), 547–558
- Stenhouse M, Zhou W & Arthur R (2006). *Assessment of the long-term fate of CO<sub>2</sub> injected into the Weyburn field: system-level modeling of CO<sub>2</sub> migration and potential impacts*. In Lombardi et al. (editors), *Advances in the geological storage of carbon dioxide*, pp 231–242. [http://link.springer.com/content/pdf/10.1007%2F1-4020-4471-2\\_19.pdf](http://link.springer.com/content/pdf/10.1007%2F1-4020-4471-2_19.pdf)
- Stokka S (2007). *Enhanced oil recovery*. *Oil and Gas Review*, issue II. <http://www.touchoilandgas.com/enhanced-recovery-a7713-1.html>
- Savage D, Maul P, Benbow S & Walke R (2004). A generic FEP database for the assessment of long-term performance and safety of the geological storage of CO<sub>2</sub>. <http://www.ieaghg.org/docs/QuintessaReportIEA.pdf>
- Shao R & Stangeland A (2009). *Amines used in CO<sub>2</sub> capture- health and environmental impacts*. The Bellona Foundation. [http://www.bellona.org/reports/amines\\_used](http://www.bellona.org/reports/amines_used)
- Solomon S (2007). *Security of CO<sub>2</sub> storage in Norway*. Bellona Foundation fact sheet [http://www.bellona.org/filearchive/fil\\_Factsheet\\_Security\\_of\\_CO2\\_storage\\_in\\_Norway\\_-\\_english\\_-\\_rev\\_16aug07.pdf](http://www.bellona.org/filearchive/fil_Factsheet_Security_of_CO2_storage_in_Norway_-_english_-_rev_16aug07.pdf)
- Stephens J & Liu Y (2012). *The evolving international CCS community*. In Markusson, N, Shackley, S, and Evar, B, editors, *The social dynamics of carbon capture and storage*. Abingdon, UK: Routledge, Taylor and Francis
- Styring P, Jansen D, de Coninck H, Reith H & Armstrong K (2011). *Carbon capture and utilisation in the green economy – using CO<sub>2</sub> to manufacture fuel, chemicals and materials*. The Centre for Low Carbon Futures, report no. 501. [http://www.policyinnovations.org/ideas/policy\\_library/data/01612](http://www.policyinnovations.org/ideas/policy_library/data/01612)
- Telikapalli V, Kozak F, Francois J, et al. (2011). *CCS with the Alstom chilled ammonia process development program –field pilot results*. *Energy Procedia* **4**, 273–281
- Tenaska Trailblazer Partners, LLC (2011). *Cooling alternatives evaluation for a new pulverized coal power plant with carbon capture*. Report to the Global CCS Institute. <http://cdn.globalccsinstitute.com/sites/default/files/publications/24367/cooling-study-report-2011-09-06-final-w-attachments.pdf>
- Tetteroo M & van der Ben C (2011). *Knowledge sharing report – CO<sub>2</sub> liquid logistics shipping concept business model*. Global CCS Institute knowledge sharing report 10: CINTRA business model, November 2011. <http://cdn.globalccsinstitute.com/sites/default/files/publications/25491/co2-liquid-logistics-shipping-concept.pdf>
- Tichy G (2004). *The over-optimism among experts in assessment and foresight*. *Technological Forecasting and Social Change* **71**, 341–363
- Total (2007). *Lacq CO<sub>2</sub> Capture and Geological Storage Pilot Project*. [http://www.total.com/MEDIAS/MEDIAS\\_INFOS/1872/EN/CO2-Lacq-Total-Project-Information-dossier.pdf](http://www.total.com/MEDIAS/MEDIAS_INFOS/1872/EN/CO2-Lacq-Total-Project-Information-dossier.pdf)
- Toth F (editor) (2011). *Geological disposal of carbon dioxide and radioactive waste: a comparative assessment*. *Advances in Global Change Research*, vol. 44. Springer
- Trumbore S (2011). *Persistence of soil organic matter as an ecosystem property*. *Nature* **478**, 49–56
- Upham P & Roberts T (2010). *Public perceptions of CCS: the results of NearCO<sub>2</sub> European focus groups*. NEARCO<sub>2</sub>, 32 pp. [http://www.communicationnearco2.eu/fileadmin/communicationnearco2/user/docs/Near\\_CO2\\_WP4\\_report\\_final.pdf](http://www.communicationnearco2.eu/fileadmin/communicationnearco2/user/docs/Near_CO2_WP4_report_final.pdf)
- UK Advanced Power Generation Technology Forum (2011). *Cleaner fossil power generation in the 21st century – maintaining a leading role: a technology strategy for fossil fuel carbon abatement technologies*. [http://www.apgtf-uk.com/index.php?option=com\\_docman&task=doc\\_download&gid=18&Itemid=79](http://www.apgtf-uk.com/index.php?option=com_docman&task=doc_download&gid=18&Itemid=79)
- US Department of Energy (2008). *Weyburn carbon dioxide sequestration project*. <http://www.netl.doe.gov/publications/factsheets/project/Proj282.pdf>
- US Department of Energy (2012a). *Carbon utilization and storage atlas 2012*, 4th edition. [http://www.netl.doe.gov/technologies/carbon\\_seq/refshelf/atlasIV/Atlas-IV-2012.pdf](http://www.netl.doe.gov/technologies/carbon_seq/refshelf/atlasIV/Atlas-IV-2012.pdf)
- US Department of Energy (2012b). *Energy Department announces awards to projects advancing innovative clean coal technology*, 16 July 2012. <http://energy.gov/articles/energy-department-announces-awards-projects-advancing-innovative-clean-coal-technology>
- Vasco D, Ferretti A & Novali F (2008). *Reservoir monitoring and characterization using satellite geodetic data: Interferometric Synthetic Aperture Radar observations from the Krechba field, Algeria*. *Geophysics* **73** (6), WA113–WA122
- VCI and DECHEMA (2009). *Position paper: Utilisation and Storage of CO<sub>2</sub>*. Verband der Chemischen Industrie & Gesellschaft für Chemische Technik und Biotechnologie. [http://www.dechema.de/dechema\\_media/Downloads/Positionspapiere/Positionspapier\\_co2\\_englisch.pdf](http://www.dechema.de/dechema_media/Downloads/Positionspapiere/Positionspapier_co2_englisch.pdf)
- Vercelli S (2010). *Supporting Psychosocial Processes towards a Sustainable Energy System: the Case of CO<sub>2</sub> Geological Storage*. From Chapter 9, *Pathways to sustainable development*, Intech, December 2010. [http://cdn.intechopen.com/pdfs/12516/InTech-Supporting\\_psychosocial\\_processes\\_towards\\_a\\_sustainable\\_energy\\_system\\_the\\_case\\_of\\_co2\\_geological\\_storage.pdf](http://cdn.intechopen.com/pdfs/12516/InTech-Supporting_psychosocial_processes_towards_a_sustainable_energy_system_the_case_of_co2_geological_storage.pdf)
- Vermeulen T (2011). *Knowledge sharing report – CO<sub>2</sub> liquid logistics shipping concept (LLSC) overall supply chain optimization*. Knowledge Sharing

- Report 4 for Global CCS Institute, June 2011. <http://cdn.globalccsinstitute.com/sites/default/files/publications/19011/co2-liquid-logistics-shipping-concept-llsc-overall-supply-chain-optimization.pdf>
- Vorrias I, Atsonios K, Nikolopoulos A, Nikolopoulos N, Grammelis P & Kakaras E (2013). *Calcium looping for CO<sub>2</sub> capture from a lignite fired power plant*. Fuel (available online 23 January 2013), <http://www.sciencedirect.com/science/article/pii/S0016236113000033>
- Wall T & Yu J (2009). *Coal-fired oxyfuel technology status and progress to deployment*. In: 34th International Conference on Coal Utilisation and Fuel Systems, Clearwater, 2009.
- Wall T, Stanger R & Santos S (2011). *Demonstrations of coal-fired oxy-fuel technology for carbon capture and storage and issues with commercial deployment*. International Journal of Greenhouse Gas Control **5** (Supplement), S5–S15
- Wessling M (2011) *Physics of Membrane Separation of CO<sub>2</sub>*. In Stolten D & Scherer V (editors), *Efficient carbon capture for coal power plants*, Weinheim, Germany: Wiley-VCH
- Whitmarsh L (2011). *Scepticism and uncertainty about climate change: dimensions, determinants and change over time*. Global Environmental Change-Human and Policy Dimensions **21** (2), 690–700
- Wigley, M Bickle, M Dubacq, B and Kampman, N, (2012). *Hematite and K-feldspar dissolution rates in an exhumed CO<sub>2</sub>reservoir, Green River, Utah*. EGU General Assembly 2012, 22–27 April 2012, Vienna, Austria, p 8238
- Woolf D, Amonette J, Street-Perrott F, Lehmann J & Joseph S (2010). *Sustainable biochar to mitigate global climate change*. Nature Communications **1**, article number 56
- World Resources Institute, (2010). *Guidelines for community engagement in Carbon Dioxide Capture, Transport, and Storage Projects*. 100 pp. [http://pdf.wri.org/ccs\\_and\\_community\\_engagement.pdf](http://pdf.wri.org/ccs_and_community_engagement.pdf)
- World Steel Association (2010). *Achieving the goal of zero-waste. Fact sheet - steel industry by-products*. <http://www.worldsteel.org>
- ZEP (2008). *EU demonstration programme for CO<sub>2</sub> capture and storage (CCS): ZEP's proposal*. <http://www.zero-emissionplatform.eu/website/docs/ETP%20ZEP/EU%20Demonstration%20Programme%20for%20CCS%20-%20ZEP%27s%20Proposal.pdf>
- ZEP (2010). *CCS EII implementation plan 2010-2012*. <http://www.zeroemissionsplatform.eu/about-zep.html>
- ZEP (2011a). *The costs of CO<sub>2</sub> capture, transport and storage: post-demonstration CCS in the EU*. <http://www.zeroemissionsplatform.eu/library/publication/165-zep-cost-report-summary.html>
- ZEP (2011b). *The costs of CO<sub>2</sub> transport: post-demonstration CCS in the EU*. <http://www.zeroemissionsplatform.eu/library/publication/167-zep-cost-report-transport.html>
- ZEP (2011c). *The costs of CO<sub>2</sub> storage: post-demonstration CCS in the EU*. <http://www.zeroemissionsplatform.eu/library/publication/168-zep-cost-report-storage.html>
- ZEP (2012a). *Status Review: The formation, control and environmental fate of emissions from amine-based CO<sub>2</sub> capture plants*. <http://www.zeroemissionsplatform.eu/library/publication/187-zep-amines-report.html>
- ZEP (2012b). *Biomass with CO<sub>2</sub> capture and storage (Bio-CCS)*. <http://www.zeroemissionsplatform.eu/news/1407-biomass-with-co2-capture-and-storagebio-ccs-the-way-forward-for-europe.html>
- Zhai H, Rubin E & Versteeg P (2011). *Water use at pulverized coal power plants with postcombustion carbon capture and storage*. Environmental Science & Technology **45** (6) 2479–2485
- Zhao L, Menzer R, Riensche E, Blum L & Stolten D (2009). *Concepts and investment cost analyses of multi-stage membrane systems used in post-combustion processes*. Energy Procedia **1** (1), 269–278
- Zhou Q, Birkholzer J, Tsang C-F & Rutqvist J (2008). *A method for quick assessment of CO<sub>2</sub> storage capacity in closed and semi-closed saline formations*. International Journal of Greenhouse Gas Control **2**, 626–636
- Zhou Q, Birkholzer J, Mehnert E, Lin Y-F & Zhang K (2010). *Modeling basin- and plume scale processes of CO<sub>2</sub> storage for full-scale deployment*. Groundwater **48** (4), 494–514
- Zhou Q & Birkholzer J (2011). *On scale and magnitude of pressure build-up induced by large-scale geologic storage of CO<sub>2</sub>*. Greenhouse Gas Science and Technology **1**, 1120
- Zoback M & Gorelick S (2012). *Earthquake triggering and large-scale geologic storage of carbon dioxide*. Proceedings of the National Academy of Sciences of the United States of America **109** (26) 10164–10168

# **Annex 1 Working Group membership, meetings and presentations**

## **Working Group membership**

Professor Per Aagaard, University of Oslo, Norway

Professor Peter Balaz, Slovak Academy of Sciences, Slovakia

Professor Vicente Cortes, University of Seville, Spain

Professor Hans Hasse, University of Kaiserslautern, Germany

Dr John Holmes, Secretary to the EASAC Energy Programme

Professor Herbert Huppert (Chair), University of Cambridge, United Kingdom

Professor Marek Jarosinski, Polish Geological Institute, Poland

Dr Francois Kalaydjian, IFP Energy Nouvelles, France (from February 2012)

Professor Stefan Kaskel, Fraunhofer Institute for Materials and Beam Technology, Germany (to March 2012)

Dr Ben Laenen, VITO, Belgium (from January 2012)

Professor Manuel Lemos de Sousa, University Fernando Pessoa, Porto, Portugal

Professor Marco Mazzotti, ETH Zurich, Italy

Dr John Morris, Geological Survey of Ireland, Ireland (to June 2012)

Professor Auli Niemi, University of Uppsala, Sweden

Professor Rudy Swennen, Katholieke Universiteit Leuven, Belgium (to January 2012)

Dr Sebastian Teir, VTT Technical Research Centre of Finland, Finland

Professor Stefan Wiemer, ETH Zurich, Switzerland

The contributions to the report of Dr Cristina Rodrigues, University Fernando Pessoa, Porto, Portugal (Chapter 5) and Ms Inga von Harbou, University of Kaiserslautern, Germany (Chapter 3) are gratefully acknowledged.

## **Peer Reviewers**

The inputs from the following peer reviewers are gratefully acknowledged:

Professor Stefano Consonni, Politecnico di Milano

Professor Peter Cook, University of Melbourne

Mr John Davison, IEA Greenhouse Gas R&D Programme

Dr John Gale, IEA Greenhouse Gas R&D Programme

Dr Sam Holloway, British Geological Survey

Professor Julian Hunt, University College London

Dr Ulrich Koss, Alstom Power

Professor Emily Shuckburgh, British Antarctic Survey

## **Meetings and Presentations**

### ***Meeting 1***

Kings College, Cambridge: 26–27 October 2011

Presentations from:

Dr Mike Farley, Doosan Power systems: 'Carbon capture – an industry view'

Dr John Gale, IEA Greenhouse Gas R&D Programme: 'Overview of IEAGHG activities and capture issues'

Dr Sam Holloway, British Geological Survey: 'Challenges for geological CO<sub>2</sub> storage as a greenhouse gas mitigation option'

Dr Claus Otto, Shell Global Solutions International: 'An overview and learnings from Shell's CO<sub>2</sub> Storage Technologies Program'

Dr Sebastian Teir, VTT: 'Alternative approaches to CO<sub>2</sub> storage'

Professor Manuel Lemos de Sousa, University Fernando Pessoa: 'CCS in Portugal'

### ***Meeting 2***

ETH Zurich: 28–29 February, 2012

Presentations from:

Dr Ulrich Koss, Alstom Power: 'CO<sub>2</sub> capture technology status'

Dr Michael Kuhn, GFZ Potsdam: 'Experience at the Ketzin test site'

Dr Katarina Buhr, Swedish Environmental Research Institute: 'Public perceptions of CCS'

Dr Samuela Vercelli, Sapienza University of Rome: 'Key issues about the introduction of CCS in our society'

Dr Samuel Abiven, University of Zurich: 'Biochar: A new tool to improve soil fertility and carbon storage in the soils?'

Professor Haroun Mahgerefteh, University College, London: 'CO<sub>2</sub> transportation for CCS'

Professor Luca Bretschger, ETH Zurich: 'Durban, CCS and CDM'

Professor Manuel Lemos de Sousa, University Fernando Pessoa: 'In-seam coal and the CCS technologies scenario: an overview'

### ***Meeting 3***

Royal Belgian Academy of Sciences, Brussels: 16 May 2012

### ***Meeting 4***

Frankfurt Airport Conference Centre: 5 July 2012

## Annex 2 Glossary

**Absorption/absorber:** absorption is a physical or chemical process in which molecules of a substance are taken up into a bulk phase which may be a gas, liquid or solid. An absorber is an item of equipment that provides for absorption to take place.

**Acid gas:** is a gas mixture containing significant quantities of hydrogen sulphide, carbon dioxide, or similar acidic constituents.

**Adsorption:** is the adhesion of molecules from a gas or liquid to a surface.

**Amine:** Amines are derivatives of ammonia, wherein one or more hydrogen atoms have been replaced by a substituent such as an alkyl or aryl group. In **sterically hindered amines** the reactivity of the molecule is adjusted to prevent unwanted side-reactions.

**Cap rock:** in the context of CO<sub>2</sub> storage is the impermeable rock overlying the permeable rock in which the CO<sub>2</sub> is stored.

**Clean development mechanism:** is one of the flexibility mechanisms defined in the Kyoto Protocol that provides for emissions reduction projects which generate Certified Emission Reduction units which may be traded in emissions trading schemes.

**Coal rank:** is the degree of alteration (or metamorphism) that occurs as a coal matures from peat to anthracite.

**Cryogenic distillation:** is similar to other distillation processes except that it is used to separate components of a gaseous mixture at very low temperatures.

**Deep saline aquifers:** saline water-bearing reservoir rocks at depths greater than approximately 800 m where CO<sub>2</sub> is likely to be stored in the dense phase.

**Desorption/desorber:** desorption is a phenomenon whereby a substance is released from or through a surface. A desorber is an item of equipment in which desorption take place.

**EOR/EGR:** enhanced oil recovery/enhanced gas recovery.

**Fluid catalytic cracker:** is widely used to convert the high-boiling, high-molecular weight hydrocarbon fractions of petroleum crude oils to more valuable gasoline, olefinic gases and other products.

**Gt/Mt:** 10<sup>9</sup>/10<sup>6</sup> tonnes.

**Hydrates:** (also known as clathrates) are substances that contain water.

**Injectivity:** the rate at which CO<sub>2</sub> can be injected into a storage reservoir.

**Ionic liquids:** are salts in the liquid state.

**kW<sub>e</sub>/MW<sub>e</sub>/GW<sub>e</sub>:** units of electrical power. The basic unit is the watt, which is equal to 1 joule (unit of energy) flowing per second: kW is the symbol for a thousand watts (kilowatts), MW the symbol for a million watts (megawatts), and GW the symbol for a billion watts (gigawatts).

**Levelised cost of electricity:** the cost of generating a unit of electricity taking account of all costs – capital, fuel, operation and maintenance, etc. – averaged over the lifetime of a generating plant.

**Mature/depleted oil and gas fields:** Mature oil and gas fields have the potential for further recovery of oil and gas through secondary recovery activities, whereas that potential has been exhausted in depleted fields.

**Millibar:** one-thousandth of a bar (a bar being a measure of the pressure exerted by a gas and is roughly equal to atmospheric pressure at sea level).

**Partial pressure:** in a mixture of ideal gases, each gas has a partial pressure that is the pressure which the gas would have if it alone occupied the volume.

**Permeability:** is a measure of the ability of a porous rock to allow fluids to pass through it.

**Porosity:** a measure of the void (i.e. 'empty') spaces in a rock, and is a fraction of the volume of voids over the total volume of the rock, between 0 and 1, or as a percentage between 0 and 100%.

**Reforming:** (autothermal and methane): processing technique by which the molecular structure of a hydrocarbon is rearranged to alter its properties.

**Supercritical:** a supercritical fluid is any substance at a temperature and pressure above its critical point, where distinct liquid and gas phases do not exist.

**Water gas shift:** the water–gas shift reaction is a chemical reaction in which carbon monoxide reacts with water vapour to form carbon dioxide and hydrogen.

## Annex 3 Potential regional approach to CCS infrastructure development in Europe

To facilitate the development of CCS in Europe a regional approach may appropriately be taken in which integrated ‘Source to Storage’ (StS) schemes are developed in key regions (for example, North Sea, Baltic Sea, Poland-Meklemburg, Balkans, Iberia). CO<sub>2</sub> transport networks connecting multiple sources and storage sites would be designed, developed and optimised for each of the regions. Potentially, a single operator of the transport and storage system could be established in each region, whereas capture facilities would be owned and operated by the industrial bodies responsible for each of the CO<sub>2</sub> sources.

A prerequisite for design of the transport network is to identify the key storage sites through an iterative process

of site selection, initially based on existing data but progressively requiring the acquisition of new geological data. An ‘industrial approach’ to CCS infrastructure development may appropriately be used comprising site screening, site selection, preliminary investment decision (concerns investment in new data acquisition and CCS Infrastructure design), site characterisation, and final investment decision (concerns completion of the CCS Infrastructure).

The following table illustrates the potential sequence of activities and decision points: the timings given are intended just to be illustrative of a possible timeline. In practice, timings will differ between regions.

	<b>Recommended actions</b>	<b>Goals and work packages</b>	<b>Stakeholders</b>	<b>Approximate deadline optimistic/ pessimistic</b>	<b>Funding sources</b>
1	Assessment of CO <sub>2</sub> storage potential	The first estimation is mostly done in the frame of international cooperation (Castor, GeoCapacity, etc.) and national R&D projects	Different scientific institutions and national surveys	2010 done	Public: EU + national,
2	Site screening	Analysis of entire set of existing geological data to do the following: <ul style="list-style-type: none"> <li>• normalise site description and methodology of capacity assessment across the EU</li> <li>• identify the most promising storage sites</li> <li>• evaluate static and dynamic capacity of sites</li> <li>• preliminary risk assessment for the most promising storage sites</li> <li>• define Integrated StS Regions in EU considering geological and industrial constraints</li> </ul>	Different scientific institutions and national surveys (may be coordinated by EurGeoSurveys)	3–4 years Partly done 2013/2014	Public: national + EU
3	Site selection and transport planning	Preparation of initial StS scenarios for Integrated StS Regions: <ul style="list-style-type: none"> <li>• evaluation of economic performance of the storage sites</li> <li>• linking the CO<sub>2</sub> sources with the storage sites</li> <li>• optimisation of principal pipeline network for regions</li> <li>• prediction (modelling) of environmental consequences of industrial-scale injection</li> <li>• legal and logistic recommendations for the Regions</li> <li>• cross-Region interconnections</li> </ul>	Institutions responsible for strategic planning (energy sector) and infrastructure (pipelines), national surveys organized in international programmes	3–4 years 2016/2018	Public: international + EU
4	Preliminary investment decision	Decisions at EU and national levels: <ul style="list-style-type: none"> <li>• overview of global economic and legal context of CCS (actual cost of capture)</li> <li>• overview of the progress of Demonstration Projects (until the time injection should start)</li> <li>• recommendations of the most effective way to develop CCS Infrastructure for Integrated StS Regions</li> <li>• decisions about continuation of investment in site characterisation for Industrial Stage</li> </ul>	EU Committee + national governments	1 year 2017/2019	Public: EU + national

*Table continues*

Table continued

5	Site characterisation (case of regional operator)	Data acquisition for selected Principal Storage sites in the Integrated StS Regions (number of sites depends on required CO <sub>2</sub> storage capacity for regions): <ul style="list-style-type: none"> <li>• projects of geological works/research</li> <li>• field data acquisition</li> <li>• data interpretation and modelling for storage</li> <li>• updating the StS scenarios</li> <li>• design of Principal Pipeline corridors</li> <li>• adjustment of legislation</li> </ul>	regional/national operators, national surveys, scientific institutions and contractors	5–6 years 2022/2025	Public + private
6	Final investment decision	Decision at EU and national levels conditioned on: <ul style="list-style-type: none"> <li>• StS scenarios should be accepted</li> <li>• Global Emissions Trading System potentially in place</li> <li>• the economic viability of the CCS has to be possible to assess</li> <li>• preliminary results of Demonstration Projects has to be positive</li> </ul>	EU Committee + national governments	1 year 2023/2026	Public: EU, national
7	Design and construction of regional and national infrastructure	Completion of infrastructure <ul style="list-style-type: none"> <li>• Principal Storage sites and Principal Pipeline network design</li> <li>• construction of Principal Storages and Pipelines</li> <li>• Installation of capture facilities and construction of connector pipelines</li> </ul>	Regional/national operators + industry and contractors	4–6 years first installations 2027/2032	Private + public
8	Beginning of industrial storage	Connection of significant number of the CO <sub>2</sub> emitters to the Principal Pipeline network and beginning of the Industrial CCS stage	Industry and operators	3–5 years 2030/2037	Private + public

EASAC, the European Academies Science Advisory Council, consists of representatives of the following European national academies and academic bodies:

Academia Europaea  
All European Academies (ALLEA)  
The Austrian Academy of Sciences  
The Royal Academies for Science and the Arts of Belgium  
The Bulgarian Academy of Sciences  
The Academy of Sciences of the Czech Republic  
The Royal Danish Academy of Sciences and Letters  
The Estonian Academy of Sciences  
The Council of Finnish Academies  
The Académie des Sciences  
The German Academy of Sciences Leopoldina  
The Academy of Athens  
The Hungarian Academy of Sciences  
The Royal Irish Academy  
The Accademia Nazionale dei Lincei  
The Latvian Academy of Sciences  
The Lithuanian Academy of Sciences  
The Royal Netherlands Academy of Arts and Sciences  
The Polish Academy of Sciences  
The Academy of Sciences of Lisbon  
The Romanian Academy  
The Slovakian Academy of Sciences  
The Slovenian Academy of Arts and Science  
The Spanish Royal Academy of Sciences  
The Royal Swedish Academy of Sciences  
The Royal Society  
  
The Norwegian Academy of Science and Letters  
The Swiss Academies of Arts and Sciences

For further information:

EASAC Secretariat  
Deutsche Akademie der Naturforscher Leopoldina  
German National Academy of Sciences  
Postfach 110543  
06019 Halle (Saale)  
Germany  
  
tel +49 (0)345 4723 9833  
fax +49 (0)345 4723 9839  
email [secretariat@easac.eu](mailto:secretariat@easac.eu)

EASAC Brussels Office  
Royal Academies for Science and the  
Arts of Belgium (RASAB)  
Hertogsstraat 1 Rue Ducale  
B 1000 - Brussels  
Belgium  
  
tel +32 (2) 550 23 32  
fax +32 (2) 550 22 05  
email [brusseloffice@easac.eu](mailto:brusseloffice@easac.eu)